

**All-Bottle 744/1544
Installation/Service and
User Manual**

June 1997

BERG COMPANY, LLC

FCC Information:

This device complies with Part 15 of FCC rules. Operation is subject to the following two conditions: (1) This device may not cause harmful interference and, (2) this device must accept any interference received including interference that may cause undesired operation.

Note: The user is cautioned that any changes or modifications not expressly approved by the party responsible for FCC compliance could void the user's authority to operate the equipment.

Copyright © 1996, 1997 by Berg Company. All rights reserved.

No part of this publication may be reproduced, transmitted, transcribed, stored in a retrieval system, or translated into any language in any form by any means without the written permission of Berg Company, Madison, Wisconsin.

Trademarks

All-Bottle 744 and All-Bottle 1544 are registered trademarks of Berg Company, LLC.

Other brand and product names may be trademarks or registered trademarks of their respective companies.

Berg Part Number: 5201438

Revision 1.00

Printed in U.S.A.

B.M.P.N. 5201437

Disclaimer of Warranties and Liabilities **Limited One Year Warranty**

Berg Company, a Wisconsin Limited Liability Corporation (BERG), warrants that all its Control Systems (SYSTEMS) will remain free from defects in materials and workmanship for a period of one (1) year from the date of original installation. BERG'S obligation under this Warranty shall be limited to the repair or replacement (at BERG'S option) of the SYSTEM or its defective part(s) during the warranty period. This Warranty is not assignable and is for the benefit of the original end-user purchaser only. BERG neither assumes nor authorizes anyone to assume on its behalf any obligations not covered by the Warranty.

THIS WARRANTY IS EXCLUSIVE AND IS IN LIEU OF ALL OTHER WARRANTIES, ORAL OR WRITTEN, EXPRESS OR IMPLIED, INCLUDING THE WARRANTIES OF MERCHANTABILITY AND FITNESS FOR ANY PARTICULAR PURPOSE.

CONDITION AND EXCLUSIONS

No defect (failure) caused by misuse, abuse, improper installation, lack of normal care or maintenance, accident or Act of God is covered by the foregoing Warranty. Said Warranty is limited to repair or replacement (at BERG'S option) only and does not include any labor or transportation charges or compliance with any Federal, State or local laws, codes or regulation. Notice of any claimed breach of said Warranty must be promptly given to the authorized dealer from whom the System was purchased or leased. Upon request, all Systems or parts which are claimed to be defective must be made available for inspection by and/or return to (at BERG'S option) such authorized dealer and/or BERG. No repair or replacement under said warranty will extend the original warranty period.

LIMITATION OF LIABILITY

IN NO EVENT SHALL BERG BE LIABLE UNDER ANY TORT, CONTRACT OR OTHER LEGAL THEORY FOR ANY LOSS, COST, EXPENSE OR INCIDENTAL OR CONSEQUENTIAL DAMAGES OF ANY KIND IN CONNECTION WITH THE DESIGN, SALE, USE, REPAIR AND/OR REPLACEMENT OF ANY SYSTEM OR PART THEREOF, EXCEPT AS SPECIFICALLY NOTED ABOVE.

BERG COMPANY

Disclaimer of Other Warranties and Liabilities

While all reasonable care has been taken in preparation of this product, it is provided "as is," without warranty as to performance or fitness except as expressly stated above. The entire risk as to the quality of output developed with this product is assumed by the user.

Berg Company does not warrant that the software or system will meet any particular requirements of the user, other than as expressly stated above, and specifically denies any liability for incidental or consequential damages resulting from the use of this software or system.

Berg Company also specifically denies all liability for any technical or editorial omissions in its product documentation, and for any incidental or consequential damages resulting from the furnishing, performance or use of its documentation.



Contents

Safety

General Safety Precautions	vi
Safety Terms and Symbols.....	vii

Getting Started 1-1

Option Packages	1-2
System Components	1-4
Installation Game Plan	1-6
Gather Customer Setup Information	1-7
Accessing the ECU Dealer Menu	1-8
Accessing the ECU Manager Menu.....	1-9
Accessing the ECU Server Menu	1-10
Navigating the ECU Menus	1-11
Tools and Materials Required	1-14

Hardware Installation 2-1

Install the ECU	2-2
Install the All-Bottle Coded Pourers	2-4
Interface the ECU to an Electronic Cash Register	2-6
Interface the ECU to a Parallel Printer	2-8
Interface the ECU to a Serial Printer or Computer	2-10
Install Flow Meters	2-12
Install a Remote Server Access Box	2-14
Connect an External Solenoid Output	2-16
Install a Switchbox with a Serial Printer or Computer Interface	2-18
Test the System	2-20

ECU Setup 3-1

Country Setup	3-2
Volume Units	3-3
Price Format	3-4
Decimal Character	3-5
Time Format	3-6
Date Format	3-7
Return to Factory Setup	3-8
Cumulative Sales Password	3-10
Diagnostic Messages	3-11
Default Messages	3-12
Set Time and Date	3-13

Serial Port Setup	3-14
Set Station Number	3-15
Linefeeds to Printer	3-16
Enable OFF Signal	3-17

Access Keys 4-1

Read an Access Key	4-2
Read a Remote Server Access Key	4-3
Make a Manager Key	4-4
Make a Server Key	4-5
Key Assignment List	4-6

Pouring Control 5-1

Disable Unit	5-2
Enable Computer Communication	5-3
Enable Price Level Change	5-4
Reset After Pour	5-5
Server Menu Active	5-6
Restart Pour Delay	5-7

Calibration, Prices, Portions and PLUs 6-1

Calibrate Coded Pourers	6-2
Define Portion Sizes	6-4
Define Prices	6-5
Define PLUs	6-6
Define Flow Meter Price per Unit	6-7
Set Flow Meter Counts	6-8
Clear All-Bottle Prices, Portions and PLUs	6-10
Clear Flow Meter Prices	6-11
Clear All Prices, Portions and PLUs	6-12
Portion Change Lockout	6-13

All-Bottle Pouring 7-1

Pour a Drink	7-2
Repeat a Pour	7-3
Pour with Server ID	7-4
Pour with Flow Meters and Server ID	7-6

Reports 8-1

Summary Reports (X and Z)	8-2
Detailed Reports (X and Z)	8-4
Last Z Report	8-6
Hourly Sales Report	8-8
Price Level Change Report	8-10
Configuration Report	8-12
Price/Portion Report	8-14
PLU Report	8-16
All Server Summary Reports (X and Z)	8-18
Individual Server Summary Reports (X and Z)	8-20
Individual Server Reports Using the Server Menu	8-22
Clear Cumulative Sales	8-24

Maintenance and Upgrading 9-1

Clean the ECU	9-2
Clean the Coded Pourers	9-3
Replace the ECU Battery	9-4
Change the EPROM	9-6
Install an Option Board	9-8

All-Bottle Manager Software 10-1

Install the Software	10-2
Communication Settings	10-4
Price and Volume Units	10-5
Select an ECU Type	10-6
Transfer Data between the ECU and the Computer	10-8
Define Portion Sizes and Prices	10-10
Define PLUs	10-12
Set Flow Meter Counts and Price per Unit	10-14
Print Setup Data	10-16
Key Assignment List	10-18
Generate Reports	10-20
Perform a Loopback Test	10-22
Perform a Communication Test	10-23
Check Option Package	10-24
Diagnostic Mode	10-25
All-Bottle Manager Files	10-26

All-Bottle 744/1544 Specifications	11-1
Basic System Specifications	11-2
Option Package Specifications	11-2
Technical Specifications	11-3
Troubleshooting	12-1
Bar Management Tips	13-1
Coded Pourer Assignment	13-2
Portioning Guidelines	13-8
Pricing Guidelines	13-10
Index	

General Safety Precautions

Review the following precautions to avoid injury and to prevent damage to the product.



Precautions

- To reduce the risk of electric shock, use only in a dry indoor location.
- To prevent the risk of electric shock connect the unit to a properly grounded power source using an IEC approved 3-pronged power cord. After installation of this equipment, access to the power cord and the mains power source receptacle must not be blocked or restricted.
- To avoid damage to the unit, be sure that the alternating current (AC) power supply in your area is appropriate for this equipment. Power requirements are detailed under *Technical Specifications* in the *All-Bottle 744/1544 Specifications* section of this manual.
- For technical information about this product contact your local Berg dealer or call the Berg Company at (608) 221-4281 between the hours of 8:00 A.M. and 4:30 P.M. C.S.T.

Safety Terms and Symbols

Review the following terms and symbols to avoid injury and to prevent damage to the product.

Terms in This Manual

These terms may appear in this manual:



Warning. Warning statements identify conditions or practices that could result in injury or loss of life.



Caution. Caution statements identify conditions or practices that could result in damage to this product or other property.

Terms on the Product

These terms may appear on the product:

Caution indicates a hazard to property including this product.

Symbols on the Product

The following symbols may appear on the product:



Attention. Consult accompanying documents.

SECTION

1

Getting Started

The general guidelines provided in this section can help you take the necessary steps to make each **All-Bottle 744** or **1544** installation run as smoothly as possible.

Option Packages	1-2
System Components	1-4
Installation Game Plan	1-6
Gather Customer Setup Information	1-7
Accessing the ECU Dealer Menu	1-8
Accessing the ECU Manager Menu	1-9
Accessing the ECU Server Menu	1-10
Navigating the ECU Menus	1-11
Tools and Materials Required	1-14

Option Packages

The **All-Bottle 744** or **1544** is a multi-beverage system that provides liquor control using seven (**744**) or fifteen (**1544**) different price codes. The system's multiple features come in different option packages which are defined by the hardware and firmware (EPROM) installed in the ECU. An authorized Berg dealer can upgrade a system with a new option package at any time. This manual provides the necessary detail to successfully install an **All-Bottle 744** or **1544** as well as upgrade the ECU to any option package. The **All-Bottle 744** or **1544** option packages are:

- | | |
|---------------------------------|--|
| 744-Basic | Provides liquor control using Berg's patented coded pourers. Different price codes can be programmed to pour four portion sizes at each of four price levels. Can be linked to a computer with the optional Berg software package All-Bottle Manager for ease of ECU programming. |
| 744-CR | Offers communication between the ECU and an electronic cash register in addition to the Basic functions. With this capability, sales are tallied automatically at the cash register as they occur at the bar. |
| 744-AR
1544-AR | Provides a full range of detailed sales reports in addition to a cash register interface and the Basic functions. The reports can be sent directly to a printer or computer. |
| 744-FM
1544-FM | Offers tracking of pulse output meters that monitor total sales and volume poured from beer, wine or soda lines in addition to sales reports, a cash register interface and the Basic functions. |
| 744-ID
1544-ID | Offers security and server accountability in addition to sales reports, a cash register interface and the Basic functions. The ECU can only be "unlocked" for dispensing when an active server or bartender access key is inserted. An optional remote server access box provides easy access to all servers. |
| 744-DX
1544-DX | Provides flow meter monitoring, server ID, advanced reporting and an electronic cash register interface in addition to the Basic functions. |

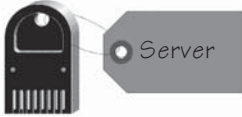

Optional server ID capability provides accountability and complete security. (option package ID, DX)

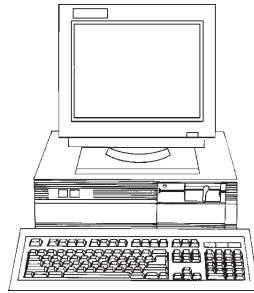

Optional All-Bottle Manager software resides on a PC and works with any option package.

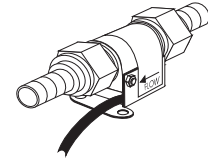

Optional flow meters can be installed to monitor beer, wine, soda or juice lines. (option package FM, DX)

All-Bottle 744 ECU

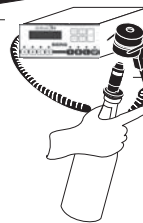

744-Basic

Activator Ring
Coded Pourer

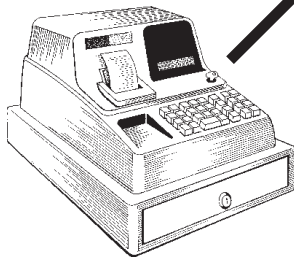

An optional ECR interface provides direct sales communication between All-Bottle 744 or 1544 and an electronic cash register. (option package AR, FM, ID, DX and 744-CR)

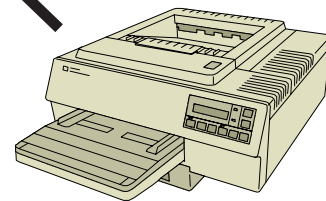

The optional advanced reporting package supports 80 column printer output of sales reports. (option package AR, FM, ID, DX)

System Components

The **All Bottle 744** or **1544** Multi-Beverage System offers basic features and several options from one compact, cost-effective unit. You can customize your system using the following components.

ECU (Electronic Control Unit)	The compact, lightweight console that controls pouring operations. One unit provides free-pouring style control for an unlimited number of brands.
Activator Ring	A circular receiver attached to the ECU that reads the electronic price information on coded pourers. It sits in a holder when not in use and easily slips over the top of a bottle for pouring.
Coded Pourer	Specially designed pourers inserted and sealed into each liquor bottle. Metal coding bands in seven (744) or fifteen (1544) different combinations electronically identify price and portion information to the ECU. Two types of pourers are available—standard flow and high flow.
Access Key	A small, electronically-coded key that must be inserted in a slot in the ECU to access the ECU menus. In option packages ID and DX, an access key must be inserted to pour drinks.
Flow Meter	Pulse output meter installed in beer, wine, soda or juice lines that transmits information to the ECU to calculate the volume of beverage poured. One ECU can monitor up to three flow meters.
Remote Server Access Box	A small key-slot box that can be used with option package ID or DX to provide easy access to the system for servers placing drink orders at the bar.
Battery Power Supply	An optional battery based power supply for use in portable or temporary installations where an AC outlet is not available.
All-Bottle Manager Software	Provides the option of entering All-Bottle setup information and generating reports at a computer rather than the ECU.

Caution



Operating Environment

The components that comprise the **All-Bottle 744** or **1544** system have been designed to perform well in a typical bar, restaurant, or stadium environment. However, as with all electronic equipment, certain guidelines should be followed in locating the components. For the ECU, Power Supply and Remote Server Access Box, a protected, dry and clean location is required. The operating temperature range for these components is from 5° C to 40° C (41° F to 104° F).

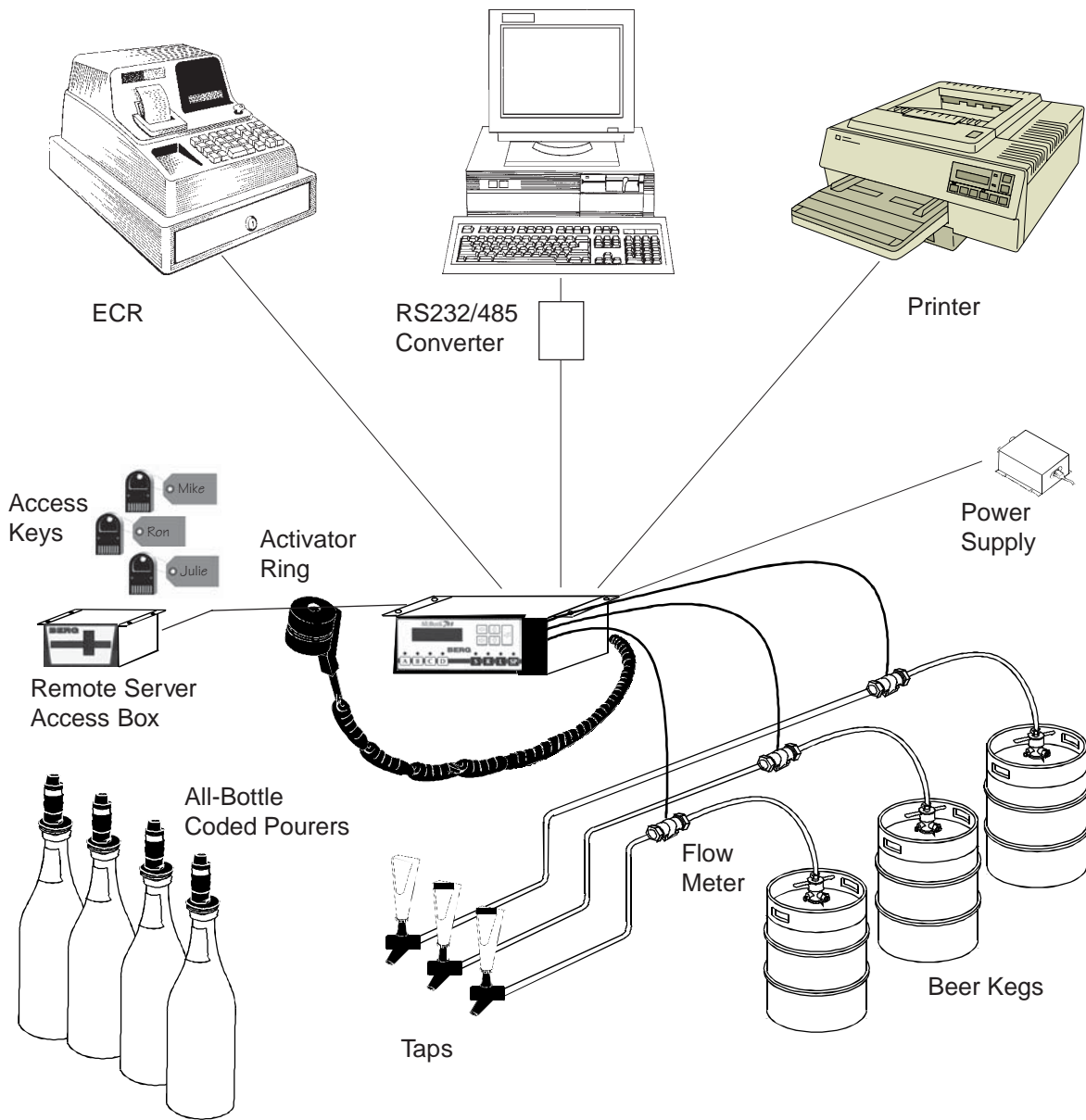

Equipment	Height	Width	Depth	Shipping Weight
Flow meter	1.2 in (30 mm)	1.0 in (25 mm)	2.4 in (61 mm)	13 oz (.4 kg)
744 or 1544 ECU	3.75 in (96 mm)	10.25 in (261 mm)	5.25 in (134 mm)	6 lb (2.7 kg)
Power Supply	1.5 in (38 mm)	2.5 in (64 mm)	4.5 in (115 mm)	2 lb (.9 kg)
Remote Server Access Box	2.5 in (64 mm)	5.0 in (127 mm)	4.5 in (115 mm)	11lb 2oz (.5 kg)
Battery Power Supply with Charger	4 in (102 mm)	6 in (152 mm)	2.5 in (64 mm)	7 lb 8 oz (3.4 kg)
744 or 1544 System (ECU, power supply, manual, cable, etc.)				9 lb (4.1 kg)

Cable	Length
Flow meter to ECU	500 feet (152.4 meters)
Power supply to ECU	3 feet (.91 meters)
Remote Server Access Box to ECU	6 feet (1.83 meters)
Computer to ECU (RS-485)	4000 feet

Electrical Requirement
100 - 240 VAC, 50-60Hz., or 12 VDC
Power Consumption
0.7 amps peak
88.5 milliamps average (300 drinks/hr)
Battery
12V 7Ah Sealed re-chargeable lead acid

Installation Game Plan

Berg offers the following checklist to expedite your installation of the **All-Bottle 744** or **1544**.

Available in Option Package(s): **744-Basic** **744-CR** **AR** **FM** **ID** **DX**

All-Bottle 744 or 1544 Installation The sequence of steps used to install an **All-Bottle 744** or **1544** system follows the order tasks appear in this manual. To help you locate information quickly and easily, related tasks are grouped throughout the manual.

- Getting Started**
- 1. Gather customer setup information and submit order for **All-Bottle 744** or **1544** to Berg.
 - 2. Record the customer's price and portion information.
 - 3. Set an installation date and assemble required tools and materials.
 - 4. Perform any pre-installation programming of the **All-Bottle 744** or **1544** ECU.

- Hardware Installation**
- 5. Install the **All Bottle 744** or **1544** ECU.
 - 6. Install the All-Bottle coded pourers.
 - 7. Interface the 744 or 1544 to an ECR (CR, AR, FM, ID, DX).
 - 8. Interface the 744 or 1544 to a printer/PC (**Manager** software, AR, FM, ID, DX only).
 - 9. Install a Remote Server Access Box (ID, DX only).
 - 10. Install flow meters (FM, DX only).

- System Configuration**
- 11. Perform one-time ECU setup tasks.
 - 12. Select pouring control features and enter into the ECU.
 - 13. Calibrate the coded pourers.
 - 14. Install **All-Bottle Manager** software (optional).
 - 15. Enter brands, prices, portion sizes and PLUs into the ECU using the ECU keypad or **Manager** software.
 - 16. Make server keys (ID, DX only). Enter valid server names into the ECU using the ECU keypad or **Manager** software.
 - 17. Enter flow meter counts and price per unit using the ECU keypad or **Manager** software (FM, DX only).

Gather Customer Setup Information

As you make ordering plans for an **All-Bottle 744** or **1544** system, gather specific information from each customer.

Available in Option Package(s): **744-Basic** **744-CR** **AR** **FM** **ID** **DX**

Assess the site and the customer's needs

Which version of **All-Bottle 744** or **1544** best meets the customer's needs? Once you've determined which option package to order, consider the following questions.

All option packages: Where will the ECU be installed? Will the **All-Bottle Manager** software be part of the system? If so, where is the computer located? How will you connect it to the ECU?

Option package CR, AR, ID, FM, DX: Does hardware need to be ordered from the cash register company?

Option package AR, ID, FM, DX: Will reports go to a printer or computer? What cables are needed? How long must they be?

Option package ID, DX: Does the customer want a remote server access box? Where will it be installed? How many servers will use the equipment?

Option package FM, DX: Where will the flow meters be installed? Where will the cables run?

With the answers to these questions, you can sketch out a rough map of the proposed system and clarify any important points with the customer.

Assess the size of the system

How many coded pourers of each price code do you need to order? See *Coded Pourer Assignment* in the *Bar Management Tips* section.

How many different sized inserts do you need for the pourers?

How many boxes of security seals?

Learn the customer's formatting preferences and price structure

Record the customer's formatting and pouring control preferences so they can be entered into the ECU. See the *ECU Setup* and *Pouring Control* sections for details regarding these choices.

Record the customer's portion sizes, prices and PLUs (if applicable).

Accessing the ECU Dealer Menu

The **All-Bottle 744** or **1544** ECU has several features that can be customized according to the needs of each owner. At the time of installation, an authorized Berg dealer performs these installation, setup and diagnostic tasks using the ECU's Dealer Menu. You can only access this menu with a valid **Dealer** access key inserted in the ECU's front key slot.

Available in Option Package(s): 744-Basic 744-CR AR FM ID DX

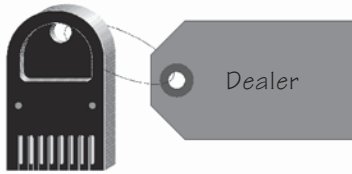

■ To access the Dealer Menu:

1. Insert a **Dealer** access key in the ECU's front key slot.
2. Press the ENTER (↵) button on the ECU keypad.

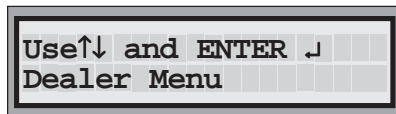

The **Dealer Menu** option is displayed.

3. Press ENTER to select this menu.



You are now inside the Dealer Menu. **Exit This Menu** is the first option in the menu. Use the up and down arrow keys to view other options.

Accessing the ECU Manager Menu

For your **All-Bottle 744** or **1544** system to operate, the ECU must be programmed with the various options available for pouring. In the ECU's Manager Menu, you perform a variety of manager functions including assigning portion sizes and prices, setting pouring controls and generating reports. You can access this menu with a **Dealer** or **Manager** access key.

Available in Option Package(s): 744-Basic 744-CR AR FM ID DX

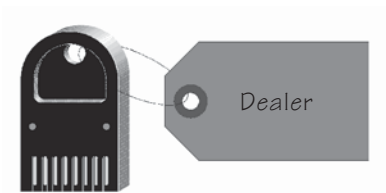

■ To access the Manager Menu (Dealer key):

1. Insert a **Dealer** access key in the ECU's front key slot.
2. Press the ENTER (↵) button on the ECU keypad.

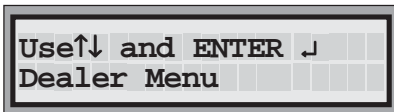

The **Dealer Menu** option is displayed.

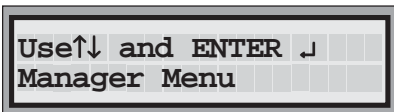

3. Use the down arrow to select the **Manager Menu** option and press ENTER.



You are now inside the Manager Menu. **Exit This Menu** is the first option in the menu. Use the up and down arrow keys to view other options.

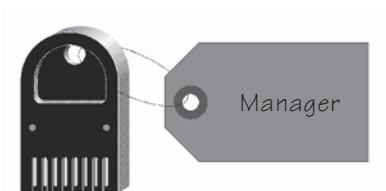

■ To access the Manager Menu (Manager key):

1. Insert a **Manager** access key in the ECU's front key slot.
2. Press the ENTER (↵) button on the ECU keypad.

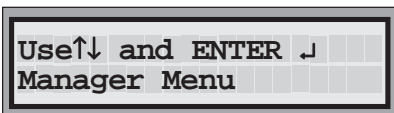

The **Manager Menu** option is displayed.

3. Press ENTER to select this menu.



You are now inside the Manager Menu. **Exit This Menu** is the first option in the menu. Use the up and down arrow keys to view other options.

Accessing the ECU Server Menu

If you have option package **ID** or **DX**, the ECU's Server Menu allows each server access to his or her own sales reports. You can access this menu with a **Dealer**, **Manager** or **Server** key.

Available in Option Package(s): 744-Basic 744-CR AR FM ID DX

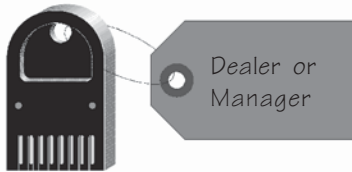

■ To access the Server Menu (Dealer/Manager key):

1. Insert a **Dealer** or **Manager** access key in the ECU's front key slot.
2. Press the ENTER (↵) button on the ECU keypad.

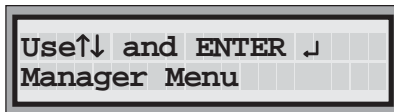

The **Dealer Menu** option or the **Manager Menu** option is displayed.

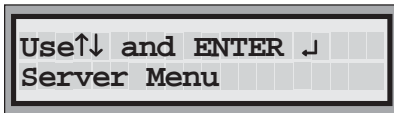

3. Use the down arrow to select the **Server Menu** option and press ENTER.



You are now inside the Server Menu. **Exit This Menu** is the first option in the menu. Use the up and down arrow keys to view other options.

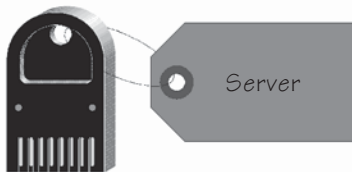

■ To access the Server Menu (Server key):

1. Insert a **Server** access key in the ECU's front key slot.
2. Press the ENTER (↵) button on the ECU keypad.

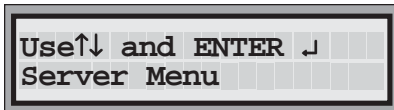

The **Server Menu** option is displayed.

3. Press ENTER to select this menu.



You are now inside the Server Menu. **Exit This Menu** is the first option in the menu. Use the up and down arrow keys to view other options.

Navigating the ECU Menus

The LCD display on the ECU functions like a narrow window, highlighting your current position in a menu. The ECU keypad is your steering device; you use it to control your movement through the menus and to select your options.

Available in Option Package(s): 744-Basic 744-CR AR FM ID DX

Reading the Display

The display window on the ECU shows two lines of text at a time. The first line is normally a prompt asking you to take some action. For instance, Use $\uparrow\downarrow$ and ENTER \downarrow means use the up and down arrow keys to change your position in the menu and ENTER to select an option.

The second line in the display window marks your current position in the menu. This second line is also used to receive user input for a selected menu option.

Using the Keypad

The ECU keypad is very easy to use. The down arrow (\downarrow) moves you forward or “down” the menu while the up arrow (\uparrow) takes you back “up” the menu. Use the left (\leftarrow) and right (\rightarrow) arrow keys to change the position of the edit cursor.

Getting Where You Want to Go

The up and down arrow keys take you “up” or “down” the menu; they do not cycle through the choices in a continuous loop. (If you are at the bottom of the menu, the down arrow does not put you back at the top.)

If you are in a sub-menu, use the up arrow to select the **Exit This Menu** option to return to the main menu.

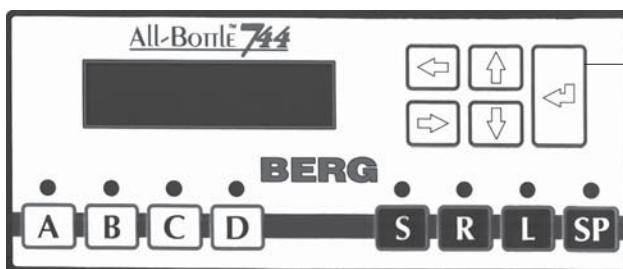

LEFT Arrow: Moves the edit cursor to the left in the display window

UP Arrow: Moves the display window to the previous menu option

RIGHT Arrow: Moves the edit cursor to the right in the display window

DOWN Arrow: Moves the display window to the next menu option



Dealer Menu Options	Available in Option Package(s)					
	Basic	CR	AR	FM	ID	DX
Exit this Menu	✓	✓	✓	✓	✓	✓
Access Keys	✓	✓	✓	✓	✓	✓
Exit this Menu	✓	✓	✓	✓	✓	✓
Read First Key	✓	✓	✓	✓	✓	✓
Read Second Key					✓	✓
Make Manager Key					✓	✓
Make Server Key					✓	✓
Country Setup	✓	✓	✓	✓	✓	✓
Exit this Menu	✓	✓	✓	✓	✓	✓
Set Volume Units	✓	✓	✓	✓	✓	✓
Set Price Format			✓	✓	✓	✓
Set Decimal Char.	✓	✓	✓	✓	✓	✓
Set Time Format			✓	✓	✓	✓
Set Date Format			✓	✓	✓	✓
Rtn to factory setup	✓	✓	✓	✓	✓	✓
Cum Sales Password			✓	✓	✓	✓
Diagnostic Messages	✓	✓	✓	✓	✓	✓
Default Messages	✓	✓	✓	✓	✓	✓

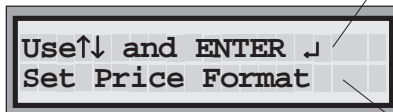

The first line in the display window tells you to use the arrow keys to move up or down the list or the ENTER key to select this option.

The second line in the display window marks your current position in the ECU menus.

Manager Menu Options	Available in Option Package(s)					
	Basic	CR	AR	FM	ID	DX
Exit this Menu	✓	✓	✓	✓	✓	✓
Disable Unit	✓	✓	✓	✓	✓	✓
Access Keys	✓	✓	✓	✓	✓	✓
Exit this Menu	✓	✓	✓	✓	✓	✓
Read First Key	✓	✓	✓	✓	✓	✓
Read Second Key					✓	✓
Make Server Key					✓	✓
Communications	✓	✓	✓	✓	✓	✓
View Reports	✓	✓	✓	✓	✓	✓
Exit this Menu	✓	✓	✓	✓	✓	✓
Summary Z	✓	✓	✓	✓	✓	✓
Detailed Z	✓	✓	✓	✓	✓	✓
Summary X	✓	✓	✓	✓	✓	✓
Detailed X	✓	✓	✓	✓	✓	✓
All Server Summary Z					✓	✓
All Server Summary X					✓	✓
Summary Z by Server					✓	✓
Summary X by Server					✓	✓

Manager Menu Options (cont.)	Available in Option Package(s)					
	Basic	CR	AR	FM	ID	DX
Last Z	✓	✓	✓	✓	✓	✓
Hourly Sales			✓	✓	✓	✓
Price Level Change			✓	✓	✓	✓
Configuration	✓	✓	✓	✓	✓	✓
Price/Portion	✓	✓	✓	✓	✓	✓
PLU		✓	✓	✓	✓	✓
Key Assignment					✓	✓
Exit this Menu					✓	✓
01 (through 15)-includes Make Key option					✓	✓
Price Level Change (by manager only)	✓	✓	✓	✓	✓	✓
Reset After Pour	✓	✓	✓	✓	✓	✓
Server Menu Active					✓	✓
Restart Pour Delay	✓	✓	✓	✓	✓	✓
Set Time and Date			✓	✓	✓	✓
Serial Port Setup	✓	✓	✓	✓	✓	✓
Exit this Menu	✓	✓	✓	✓	✓	✓
Set Baud Rate	✓	✓	✓	✓	✓	✓
Set Word Length	✓	✓	✓	✓	✓	✓
Set Parity	✓	✓	✓	✓	✓	✓
Set Stop Bits	✓	✓	✓	✓	✓	✓
Set Station Number	✓	✓	✓	✓	✓	✓
All- Bottle Setup	✓	✓	✓	✓	✓	✓
Exit this Menu	✓	✓	✓	✓	✓	✓
Code 1 (through 7) or (through 15)	✓	✓	✓	✓	✓	✓
Exit this Menu	✓	✓	✓	✓	✓	✓
Set Portion	✓	✓	✓	✓	✓	✓
Set Price			✓	✓	✓	✓
Set PLU		✓	✓	✓	✓	✓
Flow Meter Setup				✓		✓
Exit this Menu				✓		✓
Flow Meter 1 (through 3)				✓		✓
Exit this Menu				✓		✓
Meter Count				✓		✓
Set Price/Unit (levels A through D)				✓		✓
Clear Price/Por/PLUs	✓	✓	✓	✓	✓	✓
Exit this Menu	✓	✓	✓	✓	✓	✓
All-Bottle Data	✓	✓	✓	✓	✓	✓
Flow Meter Prices				✓		✓
All Price/Por/PLUs				✓		✓
Printer Config			✓	✓	✓	✓
Exit this Menu			✓	✓	✓	✓
Linefeeds to Printer			✓	✓	✓	✓
Enable OFF signal			✓	✓	✓	✓
Clear Cum Sales			✓	✓	✓	✓
Calibrate	✓	✓	✓	✓	✓	✓
Exit this Menu	✓	✓	✓	✓	✓	✓
Code 1 (through 7) or (through 15)	✓	✓	✓	✓	✓	✓

Server Menu Options	Available in Option Package(s)					
	Basic	CR	AR	FM	ID	DX
Exit this Menu					✓	✓
Summary X by Server					✓	✓

Tools and Materials Required

Berg offers the following list to help in your preparation for an **All-Bottle 744** or **1544** installation.

Available in Option Package(s): **744-Basic** **744-CR** **AR** **FM** **ID** **DX**

Tools Required

- Small slotted screwdriver
- Small Phillips (#2 pt.) screwdriver
- Small jeweler's screwdriver
- Nut driver (3/16 in)
- Hex wrench (1/16 in)
- PROM remover
- Measuring cup or graduated cylinder (for calibration)
- Tubing cutter (if installing flow meters)
- Tubing clamps (if installing flow meters)
- Diagonal cutters
- Jacket for working in cooler (if installing flow meters)
- Loop back tester

You may also need drills, holesaws and possibly other power tools if you are installing flow meters or other extensive cabling.

Materials Required

- Various flow meter fittings (if installing flow meters)
- Cable hold-downs

Equipment Preparation

Make sure the **All-Bottle 744** or **1544** equipment arrives at your shop a few days before you plan to install the system. Open the boxes and check to see you have everything you need. Also, verify nothing was damaged during shipping.

SECTION 2 Hardware Installation

Installing the hardware of an **All-Bottle 744** or **1544** system is not a difficult process. Each task can be broken down into simple procedures that are easily accomplished.

It is best to install the system early in the week, giving the bartenders a few days to operate the system before a busy weekend. It is also best to install the system early in the morning, before any bartenders arrive. Refer to this section for help with the following tasks:

Install the ECU	2-2
Install the All-Bottle Coded Pourers	2-4
Interface the ECU to an Electronic Cash Register	2-6
Interface the ECU to a Parallel Printer	2-8
Interface the ECU to a Serial Printer or Computer	2-10
Install Flow Meters	2-12
Install a Remote Server Access Box	2-14
Connect an External Solenoid Output	2-16
Install a Switchbox with a Serial Printer or Computer Interface ...	2-18
Test the System	2-20

Install the ECU

The **All-Bottle 744** or **1544** ECU is designed for easy installation under the bar top at the bartender's work station. It should be mounted 1/4 inch to 3/4 inch (.6 cm to 1.6 cm) back from the front edge of the bar to help protect it from liquid damage. Install the ECU and power supply as far away from sinks, dishwashers and other sources of water or steam as is practical.

Available in Option Package(s): **744-Basic** **744-CR** **AR** **FM** **ID** **DX**

■ To install the ECU:

1. Attach the cable that connects the power supply (AC adaptor) to the ECU. Use the 3-pin J8A port on the back of the ECU. Tighten the connecting screws.
2. Mount the power supply in a secure, dry location with the 2 wood screws provided. Select a location within 3 feet (.9 meters) of the ECU and within 5 1/2 feet (1.7 meters) of a properly grounded 110 VAC (or 220 VAC) electrical outlet.
3. Attach any flow meter, printer/PC, ECR, or remote server access box cables to the back of the ECU before mounting the ECU to insure ease of access. See the appropriate tasks in this section.
4. Secure the activator ring cable to either the right or left side of the ECU using the cable clamp and an existing screw on the ECU.
5. Mount the ECU securely under the bar using the four wood screw provided.
6. Mount the activator ring holder to the right or left of the ECU using 4 wood screws. Mount the holder to a secure surface where it will be within the bartender's convenient reach.

Note

- The connector for the power supply will fit in the J8A port or the J4B port. If it is inserted into the J4B port by mistake, the unit will not operate.
- An optional battery based power supply is available for portable ECU installations. Order Berg PN 8005700 for the battery power supply or Berg PN 8005708 for the battery and a charger.

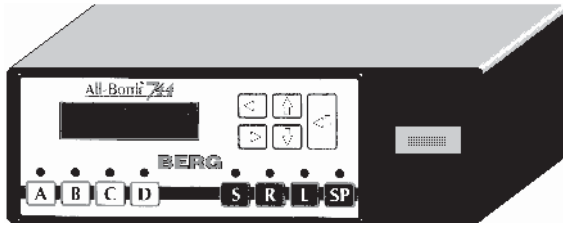

All-Bottle 744 ECU



Activator ring holder

Activator ring

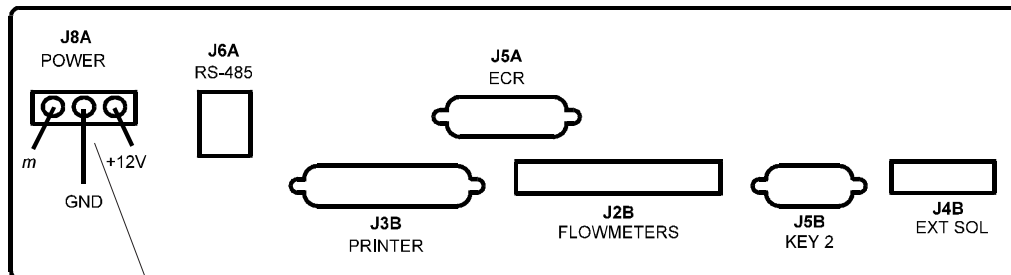

Connect the power supply to the back of the ECU

Caution



Operating Environment

The components that comprise the **All-Bottle 744** or **1544** system have been designed to perform well in a typical bar, restaurant, or stadium environment. However, as with all electronic equipment, certain guidelines should be followed in locating the components. For the ECU, Power Supply and Remote Server Access Box, a protected, dry and clean location is required. The operating temperature range for these components is from 5° C to 40° C (41° F to 104° F).

Install the All-Bottle Coded Pourers

To insure a perfect fit in each liquor bottle, Berg offers inserts (the part of the coded pourer that fits in the bottle) in four sizes. To complete an **All-Bottle 744** or **1544** installation, be sure to have an ample supply of varying sizes of inserts, an appropriate number of each of the seven or fifteen price coded pourers and a box of security seals.

Available in Option Package(s): 744-Basic 744-CR AR FM ID DX

■ To install the All-Bottle coded pourers:

1. Select the appropriately coded pourer for the liquor bottle and attach the right size insert. Remove a numbered seal and mylar tab from the box of security seals.
2. Firmly insert the pourer into the bottle.
3. Slide the opening in the mylar tab over the top of the pourer with the adhesive side down. Align the notch in the mylar tab with the notch in the pourer. Pull both tab ends down tight onto the neck of the bottle.
4. Wrap a numbered seal around the neck of the bottle and the mylar tab ends. Make sure you can still read the number on the seal. The lower edge of the seal should be even with the lower edge of the mylar tab ends.
5. Repeat steps 1-4 for each liquor bottle.

■ To change an insert on the All-Bottle coded pourers:

1. Remove the current insert by pulling and twisting it from the coded pourer.
2. Select a new size insert. Choose from an undersize insert (Berg PN 9007281), a standard size insert (Berg PN 9007122), an oversize insert (Berg PN 9007282) or an extra large insert (Berg PN 9008799).
3. Push the new insert onto the coded pourer.

Note

- Standard flow pourers and high flow pourers calibrate at different rates. If you are installing high flow coded pourers in an existing system with EPROM version lower than 1.09, or if you are using standard flow pourers in a system with EPROM version 1.09 or higher, see the Notes in *Calibrate Coded Pourers* in the *Calibration, Prices, Portions and PLUs* section.

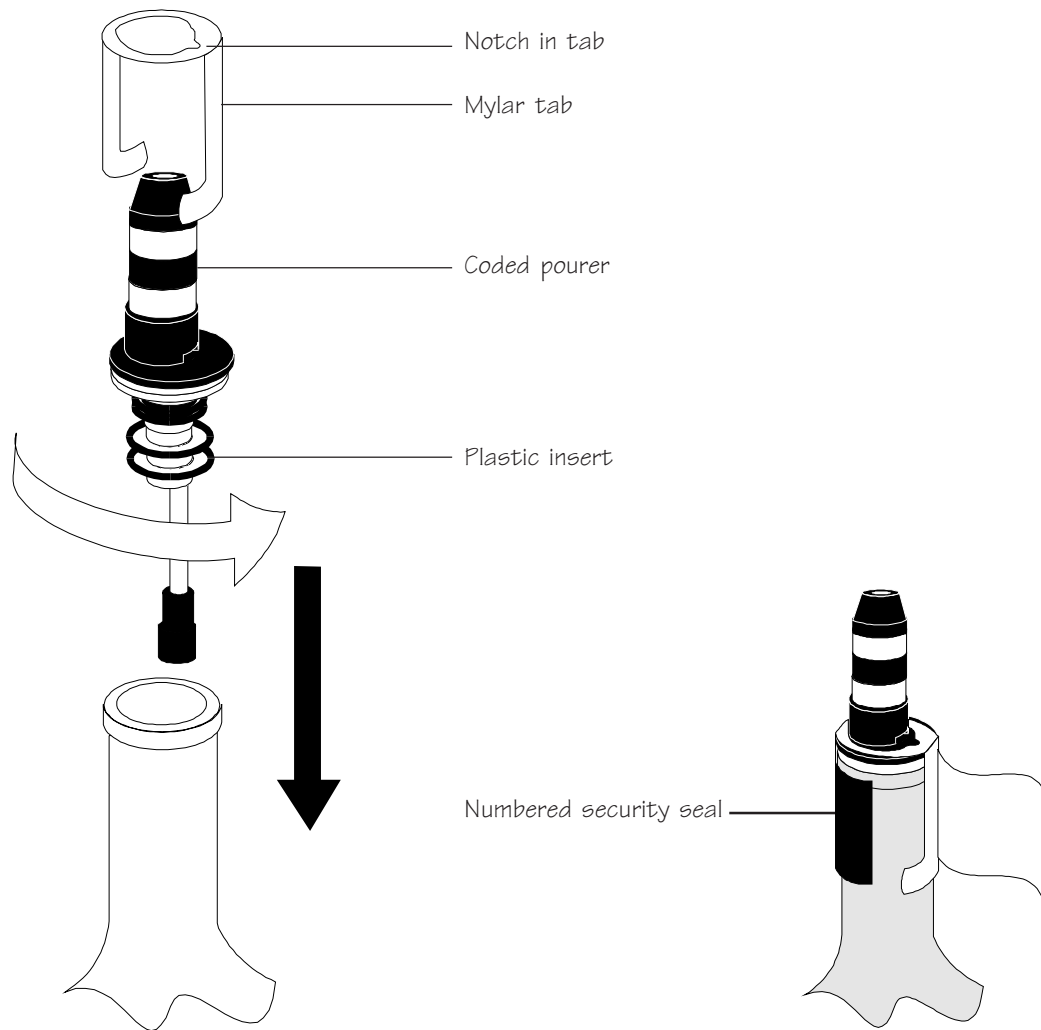

Interface the ECU to an Electronic Cash Register

If you want to take advantage of the ECR interface capability in option packages CR, AR, FM, ID or DX, you need to make the necessary hardware connections for communication between the ECU and cash register to take place.

Available in Option Package(s): 744-Basic 744-CR AR FM ID DX

■ To interface the ECU to an ECR:

1. Find out what the cash register needs to communicate with the ECU. You may have to order a specific board to install in the cash register. At the very least, you need a cable to connect the ECU to the cash register. Order these parts from the cash register company well in advance of the install date. If your cash register representative is not familiar with the Berg ECR interface, contact your Berg dealer for more details about obtaining the required interface hardware.
2. Make sure any necessary hardware is installed in the cash register. Connect one end of the cable to the cash register.
3. Connect the other end of the cable to the back of the ECU using the 15-pin J5A port. Tighten the connecting screws.
4. Get a list of the PLUs assigned to each drink at the cash register. You will need to enter these at the ECU. See *Define PLUs* in the *Calibration, Prices, Portions and PLUs* section.

Note

- If you are installing option package **CR, AR, FM, ID** or **DX** as an upgrade to an existing **All-Bottle 744** or **1544** system, you need to change the EPROM in the ECU. See *Change the EPROM* in the *Maintenance and Upgrading* section.

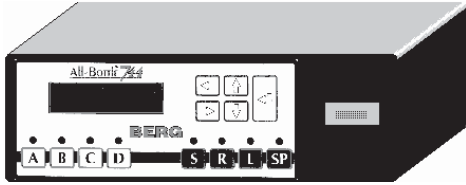

All-Bottle 744 ECU

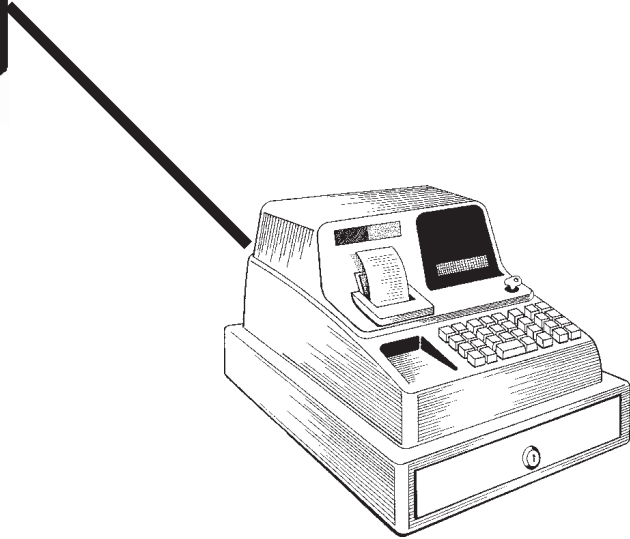

Electronic cash register

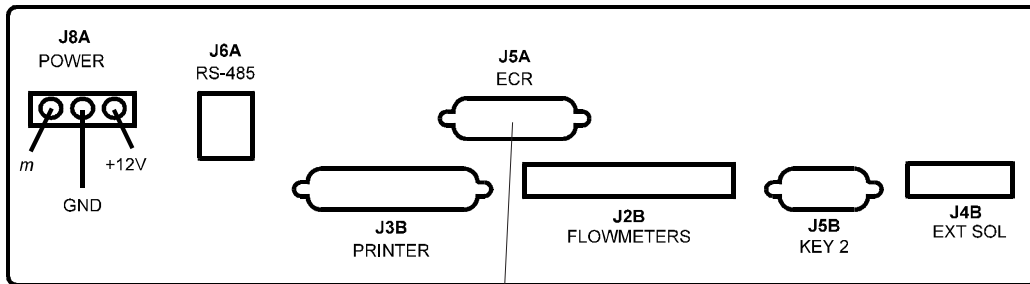

Connect the ECR cable to the J5A port on the back of the ECU

Interface the ECU to a Parallel Printer

If you are installing option package **AR**, **FM**, **ID**, or **DX**, you need to provide a connection between a printer and the ECU for printing reports. You can connect to a printer directly or connect to a computer and use the **All-Bottle Manager** software to print reports. See *Interface the ECU to a Serial Printer or Computer* in this section.

Available in Option Package(s): 744-Basic 744-CR AR FM ID DX

■ To interface the ECU to a parallel (Centronics) printer:

1. Connect a parallel printer cable to the back of the ECU using the 25-pin J3B port.
2. Connect the other end of the cable to your printer.

Note

- If you are installing option package **AR**, **FM**, **ID** or **DX** as an upgrade to an existing **All-Bottle 744** or **1544** system, you need to install an option board and change the EPROM in the ECU. See *Install an Option Board* and *Change the EPROM* in the *Maintenance and Upgrading* section.

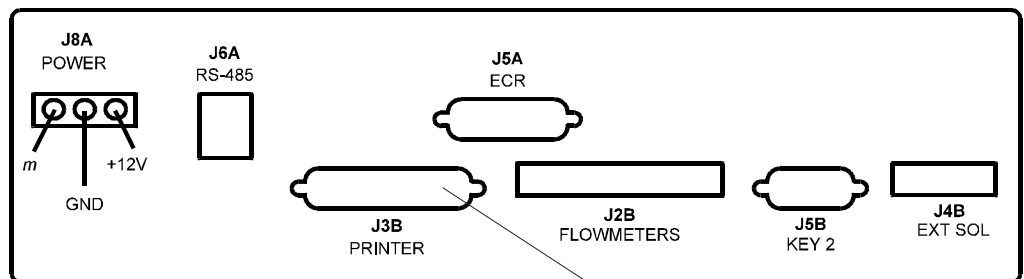
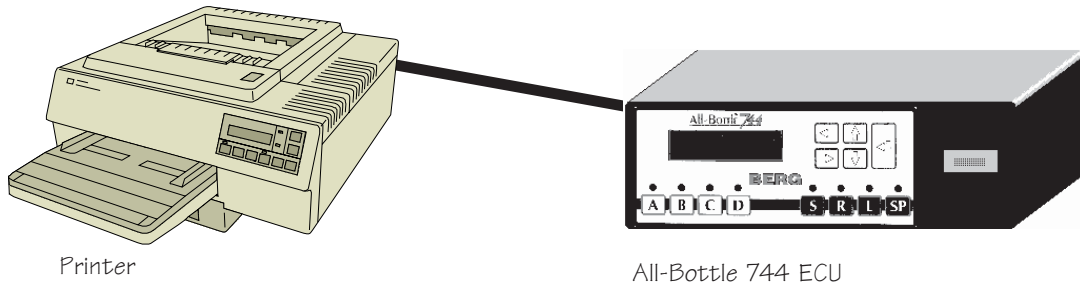

Connect the parallel printer cable to the J3B port

Interface the ECU to a Serial Printer or Computer

If you are installing **All-Bottle Manager** software (with any option package), you need to provide a connection between a computer and the ECU. If you are installing option package **AR, FM, ID** or **DX**, and not using the software, you have the option of connecting directly to a printer for reports. Connecting to a serial printer or a computer requires the RS-232 / RS-485 converter. If you are connecting the ECU directly to a parallel printer, see *Interface the ECU to a Parallel Printer* in this section.

Available in Option Package(s): **744-Basic** **744-CR** **AR** **FM** **ID** **DX**

■ To interface the ECU to a serial printer (AR, FM, ID, DX only) or computer:

1. Plug the connector from the power transformer into the side of the RS-232 / RS-485 converter (Berg PN 8009344).
2. Plug the power transformer into the same buffered power strip used by the printer or computer.
3. Insert the RS-232 / RS-485 converter into a serial port of the printer or computer and secure it with the captive screws in the connector flanges.

If the converter does not fit in the serial port, insert a 9-to25-pin adapter cable.

4. Insert the communication cable plug into the RJ-11 socket on the converter.
5. Insert the other end of the communication cable into the J6A port on the back of the ECU.

Notes

- If you have option package **744-Basic** or **744-CR**, you won't be able to interface to a printer, but you may want to interface to a computer to use the **All-Bottle Manager** software to load portion sizes or PLUs.
- To connect more than one ECU to one printer or computer see *Install a Switchbox with a Serial Printer or Computer Interface*.
- A serial printer package (Berg PN 8005546) is available from Berg which includes an Epson 300 printer, 3 ft cable and the RS-232 to RS-485 converter.

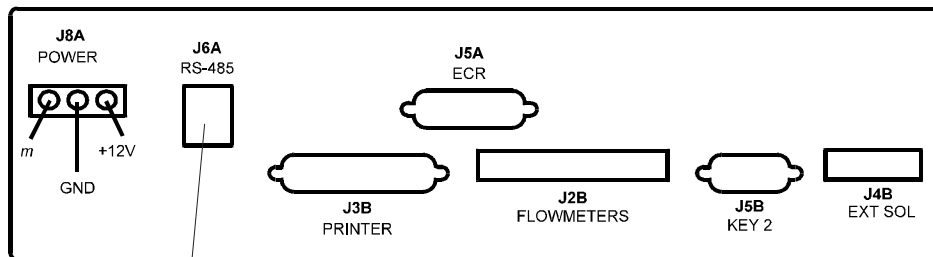
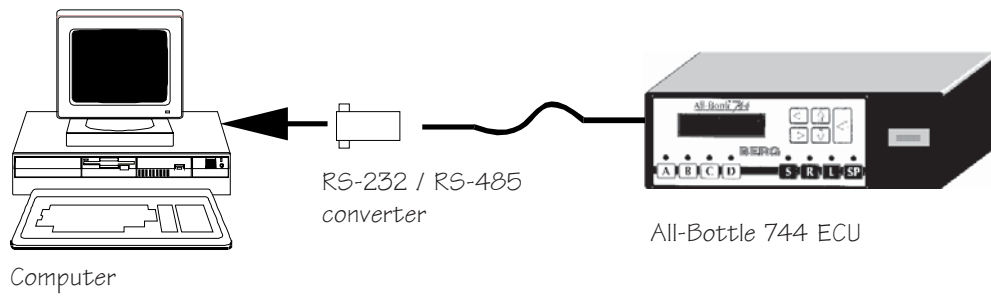
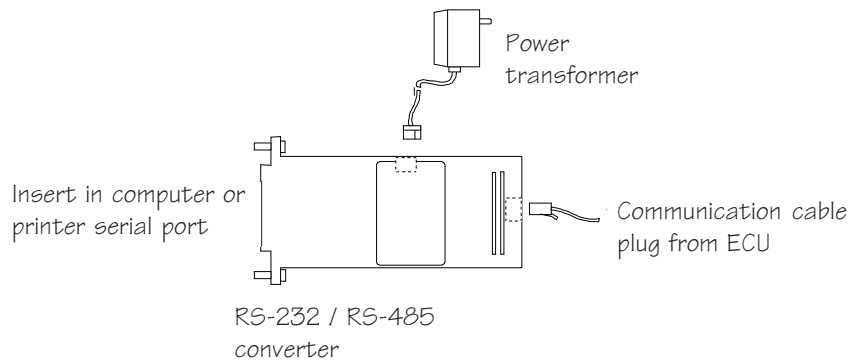

Connect the communication cable to the J6A port

Install Flow Meters

Before installing flow meters make sure the taps are closed and the door to the cooler is closed. If you leave the cooler door open, the temperature of the beverage will rise which causes excess foaming and makes calibration difficult.

Available in Option Package(s): 744-Basic 744-CR AR FM ID DX

■ To install flow meters:

1. Record and save the flow meter count number stamped on the flow meter(s). (You use this number later in the calibration process.)
2. Turn off pressure to the beverage line(s) and disconnect any kegs.
3. Determine where to insert the flow meter(s) in the line(s). Plan enough length in the line to secure the flow meter(s) to the wall or other surface.
4. Cut the beverage line.
5. Install the flow meter(s) into the line(s). First slide clamps around each end of the line, then insert the flow meter and tighten the clamps. Make sure the flow meter is installed with the “flow” arrow pointing toward the end of the tube that goes to the faucet.
6. Secure the flow meter(s) to the cooler wall (or other place) with #6 wood or sheet metal screws. You can mount the flow meter vertically on the wall or horizontally on a shelf. Do not mount the flow meter at a diagonal or any other angle. If you mount it horizontally, be sure the bracket is on the bottom or top of the flow meter and not the side. The flow meter is originally calibrated in a vertical position, so this is the preferred position for mounting.
7. Carefully strip about 3 in (7.6 cm) of outer insulation from the flow meter cable(s) going to the ECU and about 3/16 in (.5 cm) of insulation from each individual wire in the flow meter cable(s).
8. Connect the individual wires of the flow meter cable(s) to the flow meter cable terminal block. Loosen the screws on the terminal block and match each wire to the appropriate pin using the accompanying pin/signal diagram.
9. Connect the flow meter cable terminal block to the back of the ECU using the 10-pin J2B port. Tighten the connecting screws.

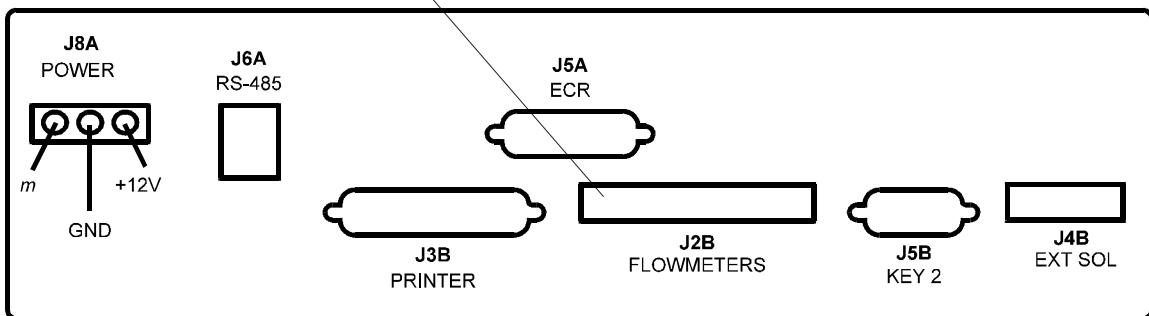
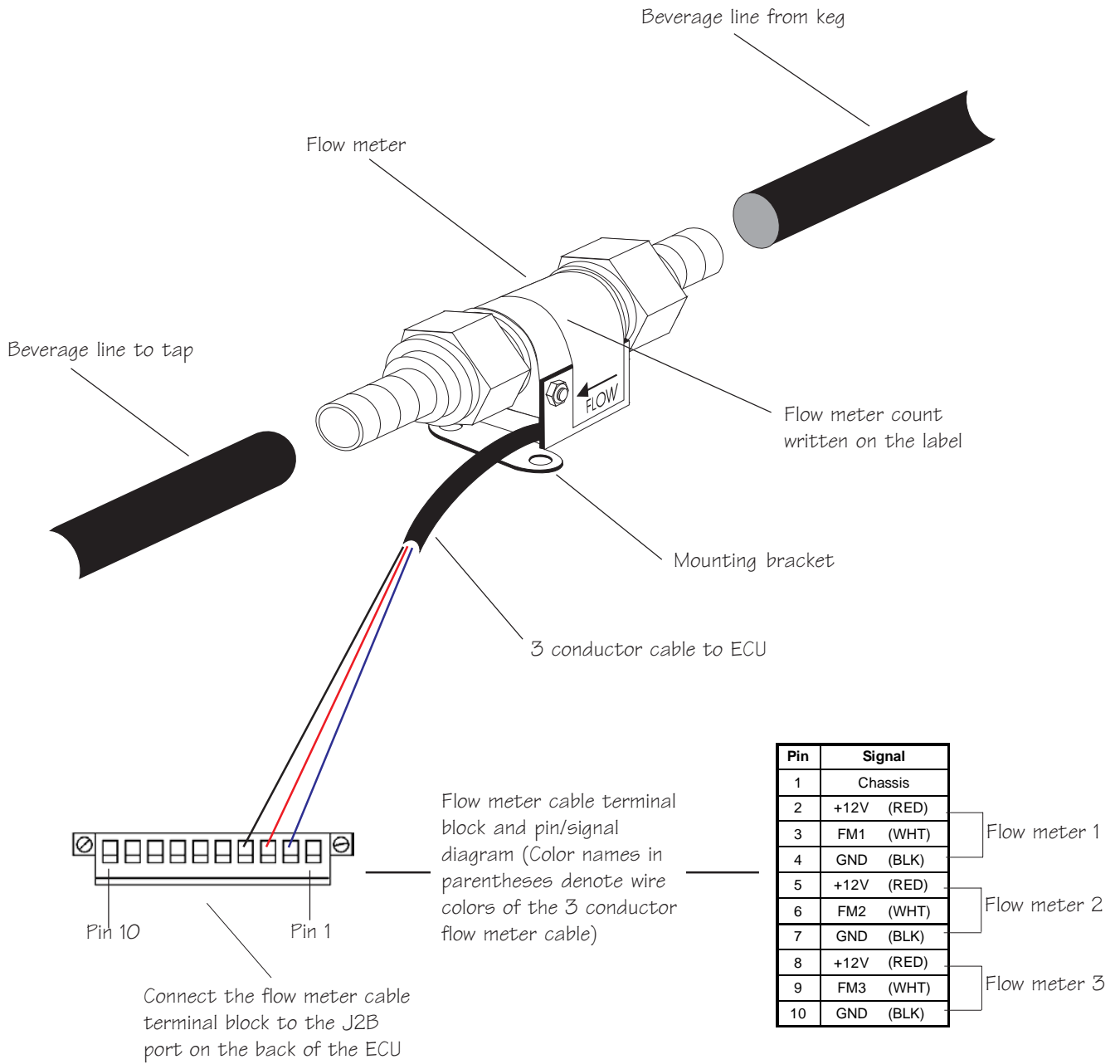

Install a Remote Server Access Box

If you are installing option package **ID** or **DX**, you may use either the key slot on the front of the ECU or a key slot in an optional remote server access box to control access to pouring. The remote server access box is usually installed on the front of the bar so servers can have access to the system without having to walk around the bar.

Available in Option Package(s): 744-Basic 744-CR AR FM ID DX

■ To install a remote server access box:

1. Mount the remote server access box underneath the bar with the 4 wood screws provided. Select a convenient location within 6 feet of the ECU.
2. Attach the cable from the remote server access box to the back of the ECU using the 9-pin J5B port. Tighten the connecting screws.

Note

- If you are installing option package **ID** as an upgrade to an existing **All-Bottle 744** or **1544** system, you need to install an option board and change the EPROM in the ECU. See *Install an Option Board* and *Change the EPROM* in the *Maintenance and Upgrading* section.

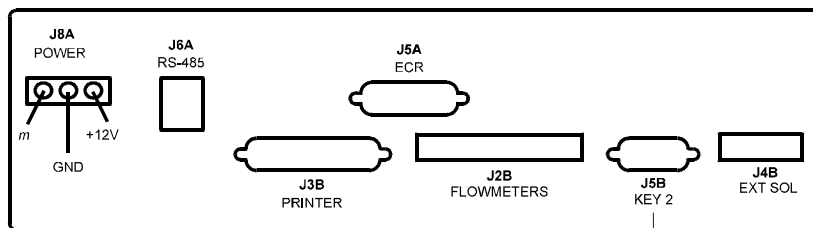
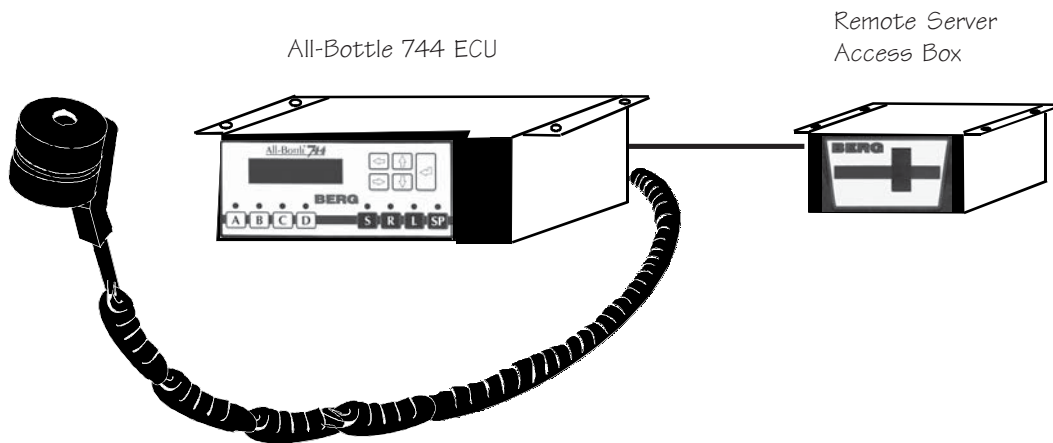

Connect the remote
server access box cable
to the J5B port on the
back of the ECU

Connect an External Solenoid Output

Although Berg does not supply or even recommend a manufacturer for a solenoid valve, there may be solenoid valves installed in the system's beverage lines. If you have option package **ID** or **DX**, these valves can be used to prevent the pouring of drinks from the lines without a valid server key. The valves may be installed in lines with or without a flow meter. When used with flow meters, the valves can prevent "unassigned sales" on system reports.

Available in Option Package(s): 744-Basic 744-CR AR FM ID DX

How it works

When a valid server key is inserted in the ECU's key slot, a signal from the ECU travels through a relay to the solenoid valve and opens the valve. The valve stays open as long as the server key is in the key slot. If there is a flow meter in the line, it monitors the quantity dispensed and the sales are assigned to the server whose key is in the key slot. Removing the server key sends a signal to close the solenoid valve and any pouring from the line is prevented.

■ To connect an external solenoid output:

1. Install the solenoid valve(s) in the beverage line(s) using the manufacturer's instructions if they are not already installed.
2. Connect the solenoid valve(s) to a relay.

(Since many solenoid valves operate on voltages other than 12 VDC, such as 24 VDC or 110 VAC, a relay is needed to isolate the **All-Bottle 744** or **1544** from those higher voltages. The ECU provides 12 VDC to the input side of the relay and the output side of the relay switches to the higher voltage needed to open the solenoid valves. Berg recommends that you always use a relay to protect the ECU even if you're using a 12 VDC solenoid valve.)

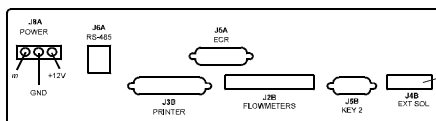

3. Connect the cable from the relay to the back of the ECU using the 3-pin J4B port. Tighten the connecting screws.

You may use this port to control almost any number of solenoid valves installed in the system.

Note

- Berg does not provide or even recommend a manufacturer for the solenoid valve or relay. This option is offered for customers that already have a beverage system with an inline solenoid.

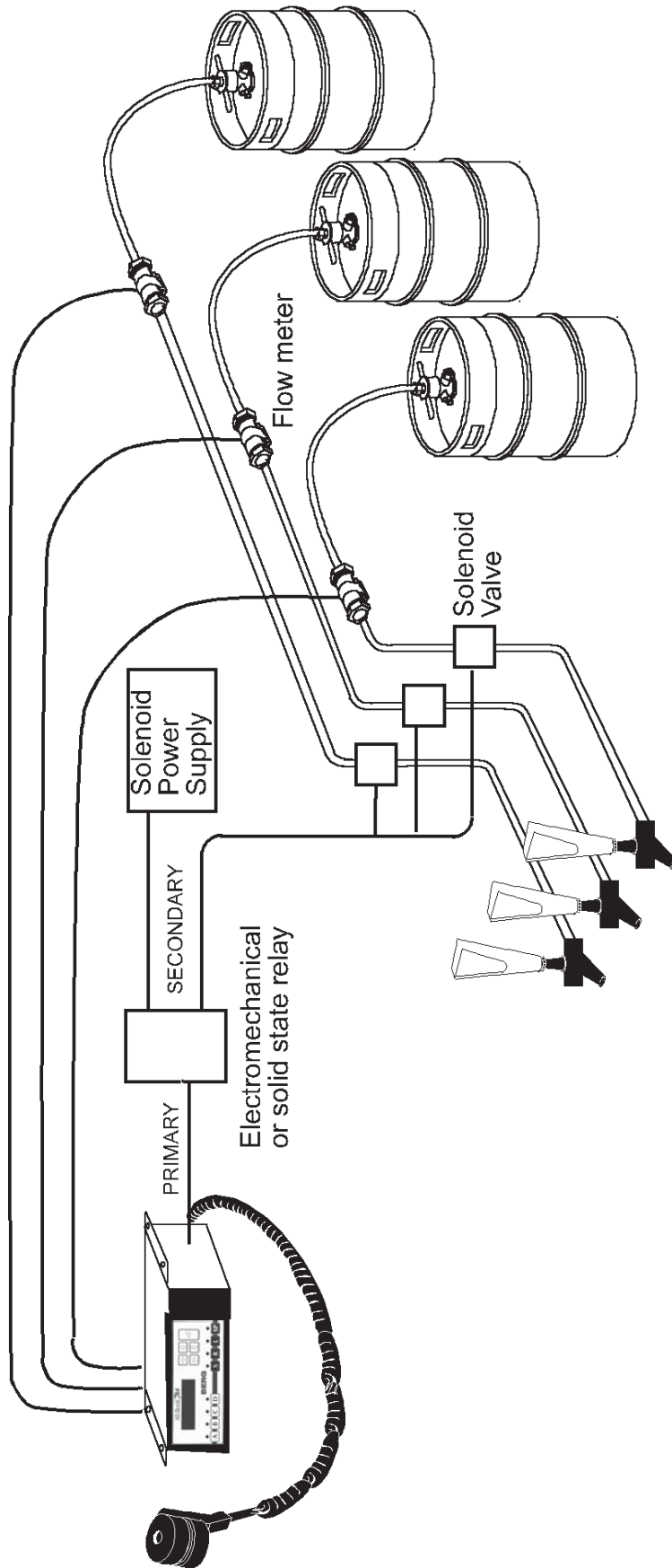

Install a Switchbox with a Serial Printer or Computer Interface

If you have more than one **All-Bottle 744** or **1544** ECU and want to interface those ECUs to one serial printer or computer, you can create a switchbox "network". The switchbox lets you control which ECU's output goes to the printer or computer. If you have option package **744-Basic** or **744-CR**, you won't be able to interface to a printer, but you may want to interface to a computer to use the **All-Bottle Manager** software to load portion sizes or PLUs.

Available in Option Package(s): **744-Basic** **744-CR** **AR** **FM** **ID** **DX**

■ To install a switchbox:

1. Choose a switchbox that has RJ-11/RJ-12 connections. Make sure you have enough communication cable to run between the ECUs and the switchbox.
2. Connect each ECU to the inputs of the switchbox using the communication cable and RJ-12 plug connectors. Use the J6A port on the back of the ECUs.
3. Attach the RS-232 to RS 485 converter (Berg PN 8009344) to a 25-pin serial port on the computer or the printer.
4. Connect the output communication cable from the switchbox to the end of the converter with an RJ-12 plug connector.
5. Connect the transformer to the side of the converter and plug the transformer into a power source.

Notes

- A serial printer (RS-232C interface) must be used if you install a switchbox. Since the most common printers on the market today use the Centronics parallel interface, a special printer may need to be ordered to implement the network as described above. A serial printer package (Berg PN 8005546) is available from Berg which includes an Epson 300 printer, 3 ft cable and the RS-232 to RS-485 converter.

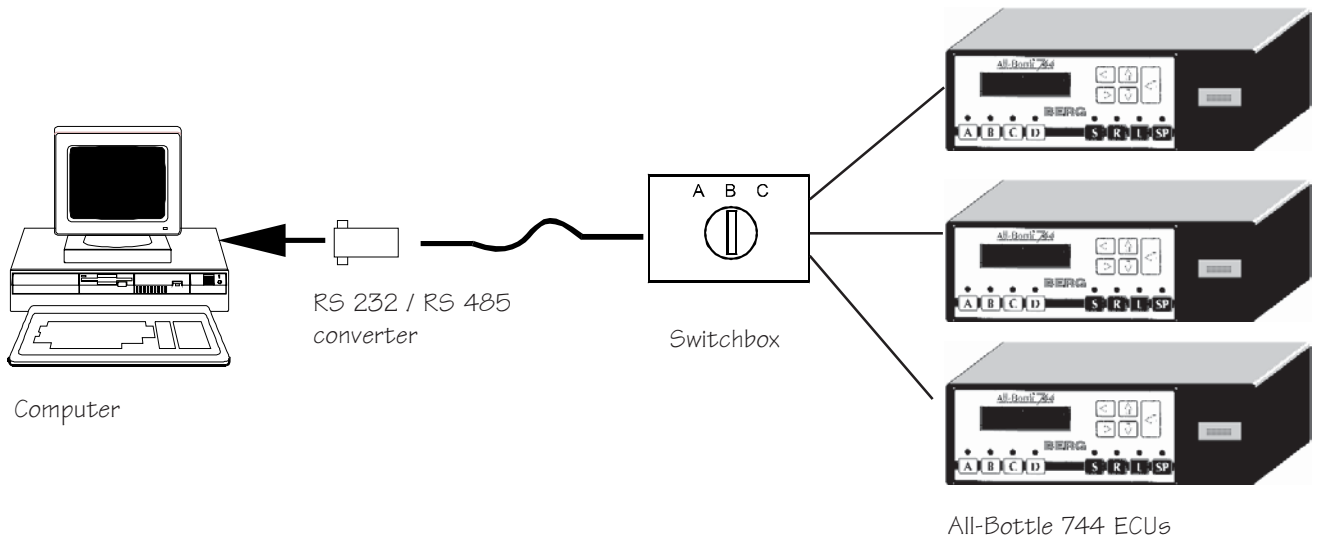
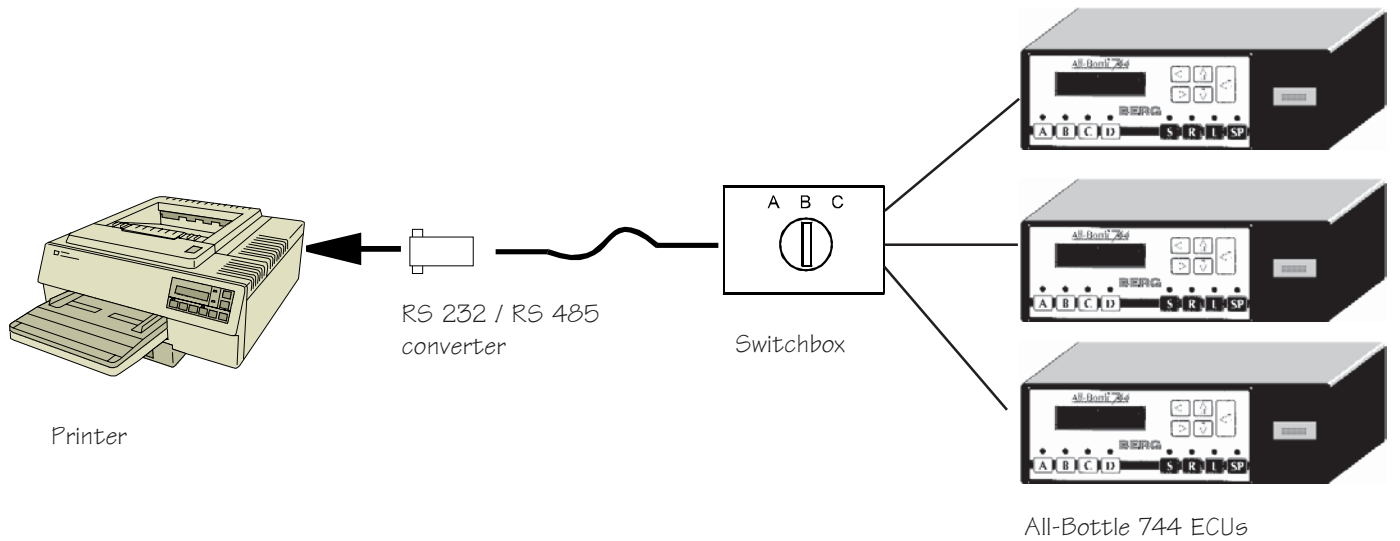

■ **To use a switchbox:**

1. Select an ECU with the switch on the switchbox.
2. If the switchbox is connected to a printer, generate reports for the selected ECU as described in the *Reports* section.
OR
If the switchbox is connected to a computer, use the **All-Bottle Manager** software to access data from the selected ECU as described in the *All-Bottle Manager Software* section.

Test the System

Now that you've installed an entire **All-Bottle 744** or **1544** system, it's time to plug in the power and make sure everything works. Do not plug in the power supply until you have completed all wiring tasks.

Available in Option Package(s): 744-Basic 744-CR AR FM ID DX

■ **To test a newly installed All-Bottle 744 or 1544 system:**

1. Make sure you've installed each component and made all cable connections.
2. Plug in the power cord coming from the power supply.
3. Pour a drink with a coded pourer using the default portion sizes if you have not pre-programmed the ECU. If you have programmed the ECU, check to see that the portion size is correct.
4. If you have an electronic cash register connected to the ECU, check to see that the correct PLU (and price) are rung up on the register.
5. Pour a drink using flow meters (if you've installed them) and record the volume of drink poured.
6. Pour a drink with a coded pourer using the remote server access box (if you've installed one).
7. Print a detailed report using the printer interface or the **Manager** software. Check the report to see that the All-Bottle portions poured in steps 3 and 6 above were recorded correctly. If flow meters are installed, check to see that the volume of the portion poured in step 5 was recorded correctly.
8. If you encounter a problem with any of these steps refer to the *Troubleshooting* section.

SECTION 3 ECU Setup

Most of the ECU setup tasks described in this section can be performed prior to installation. As soon as you find out your customer's formatting preferences you can begin programming the **All-Bottle 744** or **1544** ECU.

Country Setup	3-2
Volume Units	3-3
Price Format	3-4
Decimal Character	3-5
Time Format	3-6
Date Format	3-7
Return to Factory Setup	3-8
Cumulative Sales Password	3-10
Diagnostic Messages	3-11
Default Messages	3-12
Set Time and Date	3-13
Serial Port Setup	3-14
Set Station Number	3-15
Linefeeds to Printer	3-16
Enable OFF Signal	3-17

Country Setup

It's in the Country Setup portion of the Dealer Menu that you define the date, time, price, and measurement formats **All-Bottle 744** or **1544** uses to record data. The ECU comes with default values you can use without making any changes to Country Setup.

Available in Option Package(s): **744-Basic** **744-CR** **AR** **FM** **ID** **DX**

Country Setup Default Values

Decimal Character: . (period)

Price Format: 999.99

Volume Units: oz

Time Format: 02:45:00 PM (12 hour)

Date Format: 01/31/97

If you want to change any of these default values see the specific task headings that follow.

Volume Units

You can measure the drinks poured with an **All-Bottle 744** or **1544** system in various units. If your customer prefers metric measurements you can easily enter this format using the Volume Units feature.

Available in Option Package(s): 744-Basic 744-CR AR FM ID DX

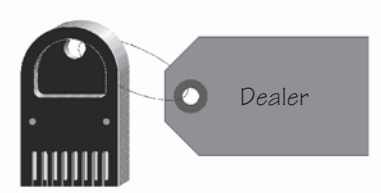

■ To change the volume units:

1. Access the Dealer Menu. (Insert your key, press ENTER, select the Dealer Menu option and press ENTER.)

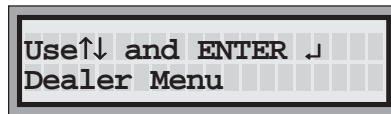

2. Use the up and down arrow keys to display the **Country Setup** option and press ENTER.

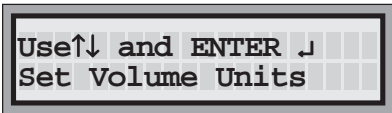

3. Use the up and down arrow keys to display the **Set Volume Units** option and press ENTER.

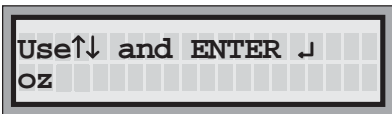

4. Use the up and down arrow keys to select ounces (oz), milliliters (ml), cubic centimeters (cc), centiliters (cl) or liters (L) and press ENTER.

The display returns to the **Set Volume Units** option.

Note

- If you have sales data stored in the ECU when you change the volume units, the reports will not reflect the actual sales. Before changing volume units run a Z report on the ECU to clear sales data.

Price Format

Different countries use the decimal character in different positions to denote prices. You can change the placement of the decimal character in your **All-Bottle 744** or **1544** system using the Price Format feature.

Available in Option Package(s): 744-Basic 744-CR AR FM ID DX

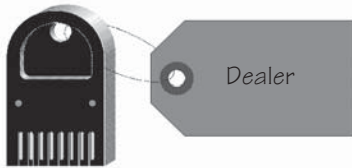

■ To change the price format:

1. Access the Dealer Menu. (Insert your key, press ENTER, select the Dealer Menu option and press ENTER.)

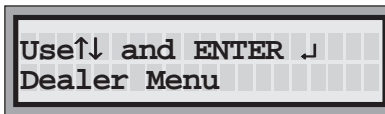

2. Use the up and down arrow keys to display the **Country Setup** option and press ENTER.

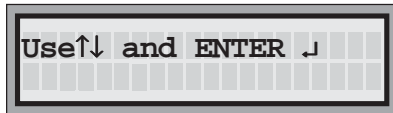

3. Use the up and down arrow keys to display the **Set Price Format** option and press ENTER.



4. Use the up arrow key to move the decimal character to the right or the down arrow key to move the decimal character to the left and press ENTER.

The display returns to the **Set Price Format** option.

Decimal Character

Some countries use a period (.) to denote a decimal character. Others use a comma (,) for this purpose. You can enter whichever character your customer prefers and **All-Bottle 744** or **1544** prints system reports with the chosen character.

Available in Option Package(s): 744-Basic 744-CR AR FM ID DX

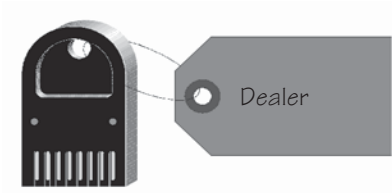

■ To change the decimal character:

1. Access the Dealer Menu. (Insert your key, press ENTER, select the Dealer Menu option and press ENTER.)

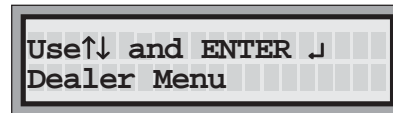

2. Use the up and down arrow keys to display the **Country Setup** option and press ENTER.

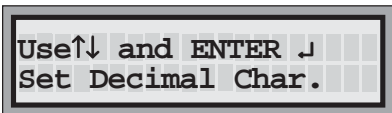

3. Use the up and down arrow keys to display the **Set Decimal Char.** option and press ENTER.

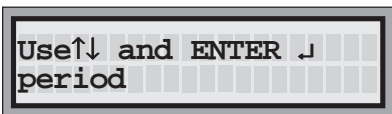

4. Use the down arrow to select **comma (,)** or the up arrow to select **period (.)** and press ENTER.

The display returns to the **Set Decimal Char.** option.

Time Format

All-Bottle 744 or 1544 can print the time on system reports using 24 hour (military) or 12 hour (standard AM/PM) notation. The default format is 12 hour notation, but you can easily change the format.

Available in Option Package(s): 744-Basic 744-CR AR FM ID DX

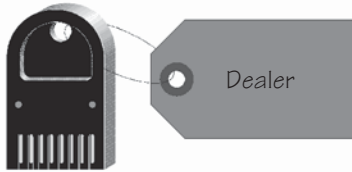

■ To change the time format:

1. Access the Dealer Menu. (Insert your key, press ENTER, select the Dealer Menu option and press ENTER.)

A terminal display showing the text "Use↑ and ENTER ↵" on the first line and "Dealer Menu" on the second line. The display is enclosed in a rectangular border.

A terminal display showing the text "Use↑ and ENTER ↵" on the first line and "Country Setup" on the second line. The display is enclosed in a rectangular border.

2. Use the up and down arrow keys to display the **Country Setup** option and press ENTER.

A terminal display showing the text "Use↑ and ENTER ↵" on the first line and "Set Time Format" on the second line. The display is enclosed in a rectangular border.

3. Use the up and down arrow keys to display the **Set Time Format** option and press ENTER.

A terminal display showing the text "Use↑ and ENTER ↵" on the first line and "12 hour" on the second line. The display is enclosed in a rectangular border.

4. Use the down arrow key to select 24 hour notation or the up arrow key to select 12 hour notation and press ENTER.

The display returns to the **Set Time Format** option.

Date Format

Your customer can choose to display the date on system reports using a month/day/year or day.month.year notation. The default format is month/day/year.

Available in Option Package(s): 744-Basic 744-CR AR FM ID DX

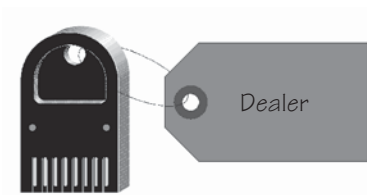

■ To change the date format:

1. Access the Dealer Menu. (Insert your key, press ENTER, select the Dealer Menu option and press ENTER.)

A screenshot of a car's display screen showing the "Dealer Menu" option. The text "Use↑↓ and ENTER ↵" is at the top, and "Dealer Menu" is highlighted in the center. The screen has a grid background.

Use↑↓ and ENTER ↵
Dealer Menu

A screenshot of a car's display screen showing the "Country Setup" option. The text "Use↑↓ and ENTER ↵" is at the top, and "Country Setup" is highlighted in the center. The screen has a grid background.

Use↑↓ and ENTER ↵
Country Setup

2. Use the up and down arrow keys to display the **Country Setup** option and press ENTER.

A screenshot of a car's display screen showing the "Set Date Format" option. The text "Use↑↓ and ENTER ↵" is at the top, and "Set Date Format" is highlighted in the center. The screen has a grid background.

Use↑↓ and ENTER ↵
Set Date Format

3. Use the up and down arrow keys to display the **Set Date Format** option and press ENTER.

A screenshot of a car's display screen showing the date format "MM/DD/YY". The text "Use↑↓ and ENTER ↵" is at the top, and "MM/DD/YY" is highlighted in the center. The screen has a grid background.

Use↑↓ and ENTER ↵
MM/DD/YY

4. Use the down arrow key to select DD.MM.YY (day.month.year) notation or the up arrow to select MM/DD/YY (month/day/year) notation and press ENTER.

The display returns to the **Set Date Format** option.

Return to Factory Setup

If you need to quickly erase all the values you've entered at the ECU use Return to Factory Setup. This feature restores default values to price, portion, PLU and flow meter tables, server ID names, calibration entries and other options entered at the ECU. It also clears accumulated sales data. See the accompanying chart for a complete listing of default values that are reset if you use Return to Factory Setup.

Available in Option Package(s): 744-Basic 744-CR AR FM ID DX

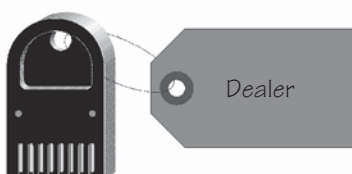

■ To return to factory setup:

1. Access the Dealer Menu. (Insert your key, press ENTER, select the Dealer Menu option and press ENTER.)

```
Use↑↓ and ENTER ↵
Dealer Menu
```

```
Use↑↓ and ENTER ↵
Rtn to factory setup
```

2. Use the up and down arrow keys to display the **Rtn to factory setup** option and press ENTER.

```
Use↑↓ and ENTER ↵
Are you sure ? : N
```

3. Use the down arrow to select **Y** (to return to factory setup) or the up arrow to select **N** (to keep the current setup) and press ENTER.

If you select **Y** the display informs you when the return to factory setup values is complete.

```
Station Reconfigured
```

The display returns to the **Rtn to factory setup** option.

Notes

- Since this feature clears sales data, be sure to run a Z report first if you have accumulated sales.
- If you have **All-Bottle Manager**, save a file at the computer with current ECU setup data before doing a Return to Factory Setup.

Dealer and Manager Menu Options Affected by Return to Factory Setup	Default Values After Return to Factory Setup			
Country Setup				
Set Price Format	oz			
Set Price Format	999.99			
Set Decimal Char.	period			
Set Time Format	12 hour (AM/PM)			
Set Date Format	MM/DD/YY			
Cum Sales Password	(none)			
Diagnostic Messages	N			
Default Messages	N			
Disable Unit	N			
View Reports				
Summary Z	cleared, Z number 0			
Detailed Z	cleared, Z number 0			
Summary X	cleared			
Detailed X	cleared			
All Server Summary Z	cleared, Z number 0			
All Server Summary X	cleared			
Summary Z by Server	cleared, Z number 0			
Summary X by Server	cleared			
Last Z	cleared			
Hourly Sales	cleared			
Price Level Change	cleared			
Key Assignment	blank except Dealer			
Price Level Change (by manager only)	Y			
Reset After Pour	Y			
Server Menu Active	Y			
Restart Pour Delay	0 seconds			
Serial Port Setup				
Set Baud Rate	19200			
Set Word Length	8-bits			
Set Parity	No Parity			
Set Stop Bits	1 Stop Bit			
Set Station Number	0			
All- Bottle Setup	(Small)	(Regular)	(Large)	(Special)
Set Portion	1.00	1.25	1.50	2.00
Set Price	1.00	1.25	1.50	2.00
Set PLU	all set to 0			
Flow Meter Setup				
Meter Count	3614			
Set Price/Unit (levels A through D)	all set to 1.00			
Printer Config				
Linefeeds to Printer	Y			
Enable OFF signal	Y			
Calibrate				
Code 1 (through 7) or (through 15)	670 (if EPROM 1.09 or higher) 1000 (if EPROM lower than 1.09)			

Cumulative Sales Password

The **All-Bottle 744** or **1544** ECU keeps a running total of all sales separate from any other sales totals. These cumulative sales are not cleared when you run Z reports. They can only be cleared by a manager. For additional security, a unique password can be defined at the ECU that must be entered to clear cumulative sales. If the manager doesn't want to password protect deletion of cumulative sales, you don't need to perform this task.

Available in Option Package(s): 744-Basic 744-CR AR FM ID DX

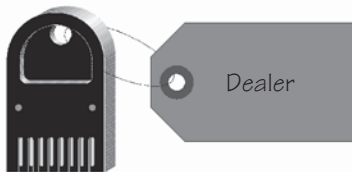

■ To enter a cumulative sales password:

1. Access the Dealer Menu. (Insert your key, press ENTER, select the Dealer Menu option and press ENTER.)

A terminal screen showing the text "Use↑↓ and ENTER ↓" on the first line and "Dealer Menu" on the second line. The screen has a grid background.A terminal screen showing the text "Use↑↓ and ENTER ↓" on the first line and "Cum Sales Password" on the second line. The screen has a grid background.

2. Use the up and down arrow keys to display the **Cum Sales Password** option and press ENTER.

A terminal screen showing the text "Use←↑↓→and ENTER ↓" on the first line and "Password _" on the second line. The screen has a grid background.

3. Key in the password and press ENTER.

Use the left and right arrow keys to move the cursor through the five password fields.

Use the up and down arrow keys to select characters from the following list: ! " # \$ % & ' () * + , - . / 0-9 : ; < = > ? @ A-Z [(yen character)] ^ _ ` a-z { | } right arrow and space in that order.

The display returns to the **Cum Sales Password** option.

Diagnostic Messages

Enabling Diagnostic Messages turns on an ECU internal diagnostic feature used by Berg service engineers. This feature sends diagnostic information through the diagnostic port to test pouring capabilities or access key insertion. For normal operations, you should disable Diagnostic Messages.

Available in Option Package(s): 744-Basic 744-CR AR FM ID DX

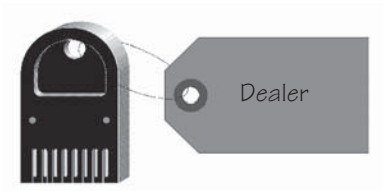

■ To enable or disable diagnostic messages:

1. Access the Dealer Menu. (Insert your key, press ENTER, select the Dealer Menu option and press ENTER.)



2. Use the up and down arrow keys to display the **Diagnostic Messages** option and press ENTER.



3. Use the up arrow to select **N** (to disable diagnostics) or the down arrow to select **Y** (to enable diagnostics) and press ENTER.

The display returns to the **Diagnostic Messages** option.

Default Messages

If you need to customize the text in the ECU display window for a non-English language, you can disable the default messages that come with the ECU and define your own messages. Check with The Berg Company to use this option. Otherwise, this option should always be enabled.

Available in Option Package(s): 744-Basic 744-CR AR FM ID DX

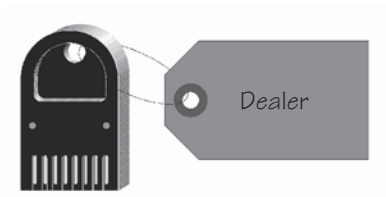

■ To enable default messages:

1. Access the Dealer Menu. (Insert your key, press ENTER, select the Dealer Menu option and press ENTER.)

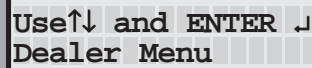
A rectangular display window with a grid background. The text "Use↑ and ENTER ↓" is on the top line, and "Dealer Menu" is on the bottom line.

2. Use the up and down arrow keys to display the **Default Messages** option and press ENTER.



3. Use the up arrow key to select **N** (to disable default messages), or the down arrow key to select **Y** (to enable default messages) and press ENTER.

The display returns to the **Default Messages** option.

Set Time and Date

You want to be sure your **All-Bottle 744** or **1544** is programmed to reflect the current time and date. This information appears at the top of every report generated by the system. Correcting the system time and date is easily accomplished at the ECU.

Available in Option Package(s): 744-Basic 744-CR AR FM ID DX

■ To set the All-Bottle 744 or 1544 system time and date:

1. Access the Manager Menu. (Insert your key, press ENTER, select the Manager Menu option and press ENTER.)

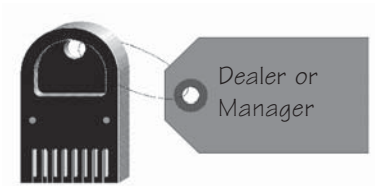

2. Use the up and down arrow keys to display the **Set Time and Date** option and press ENTER.

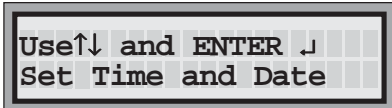

3. Key in the correct date and press ENTER.

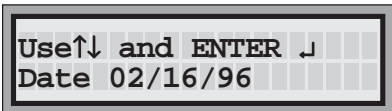

Use the up and down arrow keys to select the numbers and the left and right arrow keys to move the cursor through the date fields.

4. Key in the correct time and press ENTER.

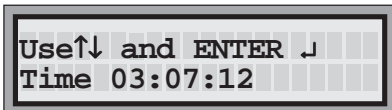

Use the up and down arrow keys to select the numbers and the left and right arrow keys to move the cursor through the time fields (HH/MM/SS) and press ENTER.

If the time format is 12 hour, use the up and down arrow keys to move the numbers in the hour fields through 12 to switch from AM to PM.

The display returns to the **Set Time and Date** option.

Notes

- To set time and date formats, see the *ECU Setup* section.
- If you are in 12 hour mode, note that AM/PM does not get highlighted with the cursor.

Serial Port Setup

If you want to set up your **All-Bottle 744** or **1544** to communicate with an IBM-compatible computer or with a serial printer you need to set the communication variables of your ECU to match those of your PC or printer. For more information about these settings, consult your printer or computer manual.

Available in Option Package(s): 744-Basic 744-CR AR FM ID DX

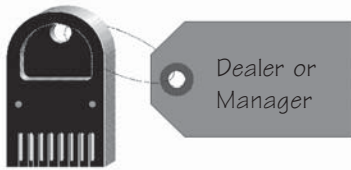

■ To change serial port settings:

1. Access the Manager Menu. (Insert your key, press ENTER, select the Manager Menu option and press ENTER.)

A terminal screen showing the text "Use↑ and ENTER ↓" on the first line and "Manager Menu" on the second line. The screen has a grid background.

A terminal screen showing the text "Use↑ and ENTER ↓" on the first line and "Serial Port Setup" on the second line. The screen has a grid background.

2. Use the up and down arrow keys to display the **Serial Port Setup** option and press ENTER.

A terminal screen showing the text "Use↑ and ENTER ↓" on the first line and "Set Baud Rate" on the second line. The screen has a grid background.

3. Use the up and down arrow keys to display the serial port setting you want to change and press ENTER.

A terminal screen showing the text "Use↑ and ENTER ↓" on the first line and "19200" on the second line. The screen has a grid background.

4. Use the up and down arrow keys to select the new setting and press ENTER.

Note

- The ECU comes with the following serial port default settings:

Baud Rate: 19200

Word Length: 8-bits

Parity: No parity

Stop Bits: 1 Stop Bit

Set Station Number

A station number is a unique number you assign to an **All-Bottle 744** or **1544** ECU to identify reports from that ECU. All reports show this station number at the top.

Available in Option Package(s): 744-Basic 744-CR AR FM ID DX

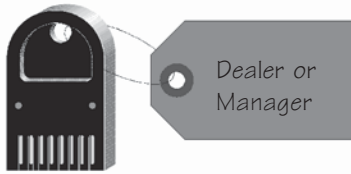

■ To set a station number:

1. Access the Manager Menu. (Insert your key, press ENTER, select the Manager Menu option and press ENTER.)

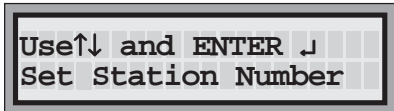
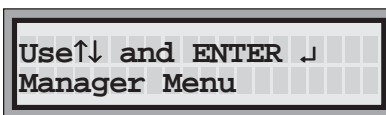

2. Use the up and down arrow keys to display the **Set Station Number** option and press ENTER.

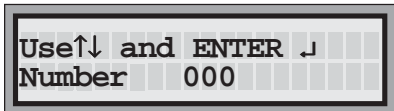

3. Use the up and down arrow keys to select a number. Use the left and right arrow keys to move the cursor through the number fields. (The valid range of station numbers is 000-255.)

The display returns to the **Set Station Number** option.

Linefeeds to Printer

If you are sending reports to a printer, unwanted linefeeds may be a problem. Unwanted linefeeds insert extra blank lines between the printed lines of the report. If you cannot disable the automatic linefeeds at the printer, use this feature to disable them at the ECU.

Available in Option Package(s): 744-Basic 744-CR AR FM ID DX

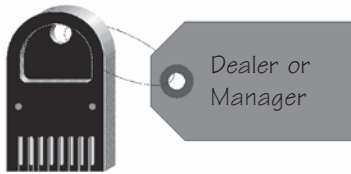

■ To send/not send linefeeds to a printer:

1. Access the Manager Menu. (Insert your key, press ENTER, select the Manager Menu option and press ENTER.)



```
Use↑↓ and ENTER ↵
Manager Menu
```



```
Use↑↓ and ENTER ↵
Printer Config
```

2. Use the up and down arrow keys to display the **Printer Config** option and press ENTER.

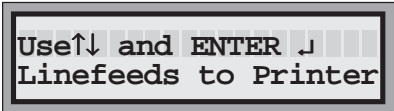

```
Use↑↓ and ENTER ↵
Linefeeds to Printer
```

3. Use the up and down arrow keys to display the **Linefeeds to Printer** option and press ENTER.



```
Use↑↓ and ENTER ↵
Send Linefeeds ? : Y
```

4. Use the down arrow key to select **Y** (send linefeeds to printer) or the up arrow key to select **N** (don't send linefeeds to printer) and press ENTER.

The display returns to the **Linefeeds to Printer** option.

Enable OFF Signal

The signal referred to in this menu option is the "online" signal the ECU checks for before sending a report to a printer. If the ECU checks and doesn't find an online parallel printer, it displays an error message. If you are using a parallel printer, that's helpful. If you are using a serial printer, it doesn't matter that the ECU detected an "OFF" (or absence of online) signal for a parallel printer; your report goes to the serial printer regardless of the error message. You can choose to have the ECU ignore the OFF signal and you'll no longer see error messages.

Available in Option Package(s): 744-Basic 744-CR AR FM ID DX

■ To enable the OFF signal of a printer:

1. Access the Manager Menu. (Insert your key, press ENTER, select the Manager Menu option and press ENTER.)

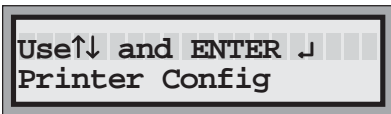
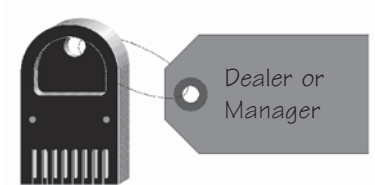

2. Use the up and down arrow keys to display the **Printer Config** option and press ENTER.

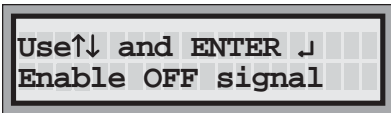

3. Use the up and down arrow keys to display the **Enable OFF signal** option and press ENTER.

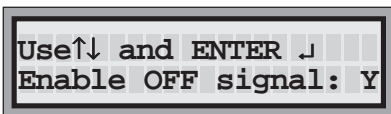

4. Use the down arrow key to select **Y** (enable OFF signal and display OFF signal error messages) or the up arrow key to select **N** (ignore OFF signal and remove OFF signal error messages) and press ENTER.

The display returns to the **Enable OFF signal** option.

Access Keys

Access keys provide convenient and secure access to the **All-Bottle 744** or **1544** ECU menus. Each **Dealer** or **Manager** key is programmed with a two character access code that determines which menu(s) can be used. These keys can also be programmed with a user name for identification purposes. If you have option package **ID** or **DX**, **Server** access keys offer complete security and accountability for all pouring operations. Each server is assigned a key programmed to permit pouring and access to a Server Menu. **Server** keys must be programmed with unique names that identify the user at the time of pouring. These names must also be entered in the Key Assignment List or pouring access will be denied.

Read an Access Key	4-2
Read a Remote Server Access Key	4-3
Make a Manager Key	4-4
Make a Server Key	4-5
Key Assignment List	4-6

Read an Access Key

You can determine the assignment of your access keys with this feature in the Dealer Menu or the Manager Menu.

Available in Option Package(s): 744-Basic 744-CR AR FM ID DX

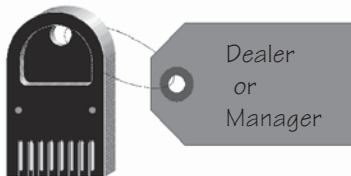

■ To read an access key:

1. Access the Dealer or Manager Menu. (Insert your key, press ENTER, select a Menu option and press ENTER.)

```
Use↑↓ and ENTER ↵
Dealer Menu
```

```
Use↑↓ and ENTER ↵
Manager Menu
```

```
Use↑↓ and ENTER ↵
Access Keys
```

2. Use the up and down arrow keys to display the **Access Keys** option and press ENTER.

```
Use↑↓ and ENTER ↵
Read First Key
```

3. Use the up and down arrow keys to display the **Read First Key** option and press ENTER.

```
Use ENTER ↵
MG Jim
```

The two character code (DL, MG) and name assigned to the access key in the ECU's key slot appears in the display window.

4. Press ENTER to return to the **Read First Key** option.

Note

- DL, MG and WT are codes designating access keys as dealer (DL), manager (MG), or server/waiter (WT) keys.

Read a Remote Server Access Key

You can determine the name assigned to a server key using this feature.

Available in Option Package(s): 744-Basic 744-CR AR FM ID DX

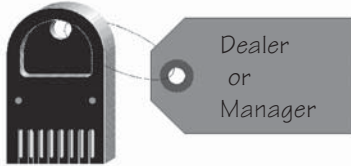

■ To read a remote server access key:

1. Access the Dealer or Manager Menu. (Insert your key, press ENTER, select a Menu option and press ENTER.)



```
Use↑↓ and ENTER ↵
Dealer Menu
```



```
Use↑↓ and ENTER ↵
Manager Menu
```

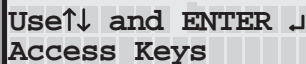

```
Use↑↓ and ENTER ↵
Access Keys
```

2. Use the up and down arrow keys to display the **Access Keys** option and press ENTER.

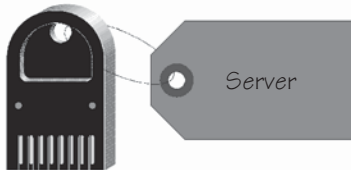

3. Insert an access key in the remote server access box.

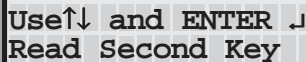

```
Use↑↓ and ENTER ↵
Read Second Key
```

4. Use the up and down arrow keys to display the **Read Second Key** option and press ENTER.



```
Use ENTER ↵
WT Don
```

The two character code (DL, MG, WT) and name assigned to the access key in the remote server access box appears in the display window.

5. If you have more than one key to read, remove the key in the box and insert the next one.
6. Press ENTER to return to the **Read Second Key** option.

Note

- If there is no access key in the remote server access box, the two character code and name assigned to the last key inserted in the box appears in the display window.

Make a Manager Key

You can turn an access key (new or previously programmed) into a manager key using this feature in the Dealer Menu at the ECU. If the customer does not have a remote server access box, you need to connect one to perform this task.

Available in Option Package(s): 744-Basic 744-CR AR FM ID DX

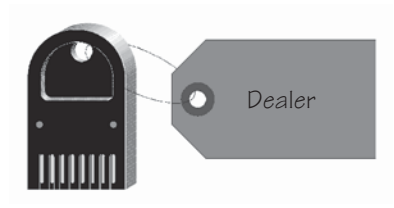

■ To make a Manager key:

1. Access the Dealer Menu. (Insert your key, press ENTER, select the Dealer Menu option and press ENTER.)

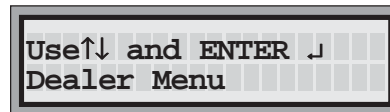

2. Use the up and down arrow keys to display the **Access Keys** option and press ENTER.

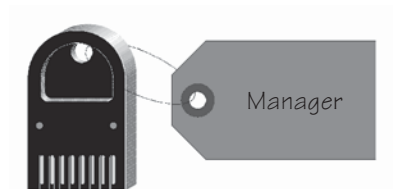

3. Insert your new access key in the remote server access box.

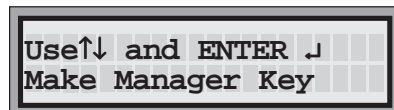

4. Use the up and down arrow keys to display the **Make Manager Key** option and press ENTER.



5. Key in the name you want to assign to the new manager key and press ENTER.

Use the left and right arrow keys to move the cursor through the ID fields. Use the up and down arrow keys to select characters from the following list: ! " # \$ % & ' () * + , - . / 0-9 : ; < = > ? @ A-Z [(yen character)] ^ _ ` a-z { | } right arrow and space in that order.

Note

- After making a manager key, you must pull it from the box and reinsert it to read it.

Make a Server Key

Once you have a remote server access box installed with your **All-Bottle 744** or **1544**, you can make an access key with a unique identifying code for each server. At any time you can change the name identifying the server key by simply reinserting the key and repeating the procedure. For the server key to be accepted at the ECU, the name assigned to the key must also be entered on the key assignment list. See *Key Assignment List* in this section.

Available in Option Package(s): 744-Basic 744-CR AR FM ID DX

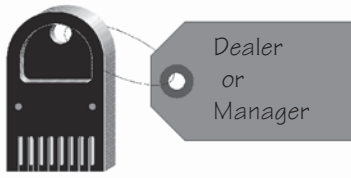

■ To make a Server key:

1. Access the Dealer or Manager Menu. (Insert your key, press ENTER, select a Menu option and press ENTER.)

Use↑↓ and ENTER ↵
Dealer Menu

Use↑↓ and ENTER ↵
Manager Menu

Use↑↓ and ENTER ↵
Access Keys

2. Use the up and down arrow keys to display the **Access Keys** option and press ENTER.

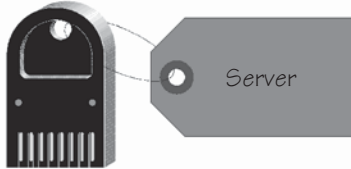

3. Insert an access key in the remote server access box.

Use↑↓ and ENTER ↵
Make Server Key

4. Use the up and down arrow keys to display the **Make Server Key** option and press ENTER.

Use←↑↓→and ENTER ↵
ID: _

5. Key in the name you want to assign to the new server key and press ENTER.

Use the left and right arrow keys to move the cursor through the ID fields. Use the up and down arrow keys to select characters from the following list: ! " # \$ % & ' () * + , - . / 0-9 : ; < = > ? @ A-Z [(yen character)] ^ _ ` a-z { | } right arrow and space in that order.

Note

- After making a server key, you must pull it from the box and reinsert it to read it.
- You can also make a server key at the time you add a server's name to the key assignment list. See *Key Assignment List* in this section.

Key Assignment List

If you have server ID, you must enter a valid server name at the ECU for each server key you want to activate. For a server to be allowed to pour, the name on the server key must match a name in the key assignment list stored in the ECU. When you add a server name to the key assignment list, you can also choose to make a server key in that name at the same time.

Available in Option Package(s): 744-Basic 744-CR AR FM ID DX

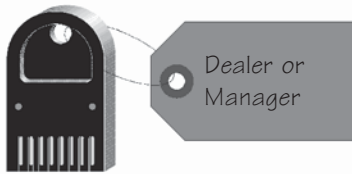

■ To list servers in the Key Assignment list:

1. Access the Manager Menu. (Insert your key, press ENTER, select the Manager Menu option and press ENTER.)

```
Use↑↓ and ENTER ↵
Manager Menu
```

```
Use↑↓ and ENTER ↵
Key Assignment
```

2. Use the up and down arrow keys to display the **Key Assignment** option and press ENTER.

```
Use↑↓ and ENTER ↵
01
```

3. Use the up and down arrow keys to select one of the numbers (up to 15) that make up the list of server key assignments and press ENTER.

The order in which servers appear in the list is not significant.

```
Use←↑↓→and ENTER ↵
ID: Don
```

4. Use the up and down arrow keys to enter the identifying name assigned to the key and press ENTER.

Use the left and right arrow keys to move the cursor through the ID fields (up to 16 spaces).

Use the up and down arrow keys to select the characters from the following list: ! " # \$ % & ' () * + , - . / 0-9 : ; < = > ? @ A-Z [(yen character)] ^ _ ` a-z { | } right arrow and space in that order. The key assignment list is case sensitive.

The display prompts you to make a server key for the name you just added to the list.

```
Use↑↓ and ENTER ↵
Make Key ? : Y
```

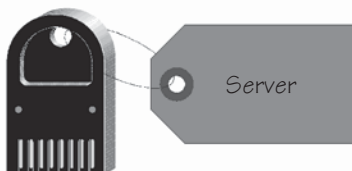

5. If you want to make a server key, insert an access key in the remote server access box.

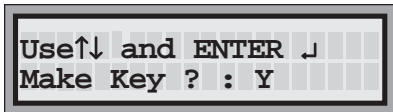

6. Use the down arrow to select **Y** (to make a server key) or the up arrow to select **N** (not to make a server key) and press ENTER.

The display returns to the name you added to the key assignment list.

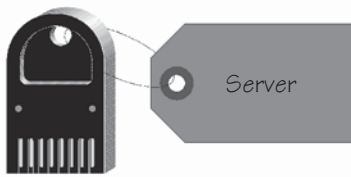

7. If you made a server key, remove it from the remote server access box.

8. Repeat steps 3 through 7 for each server in the key assignment list.

SECTION

5

Pouring Control

You can enable or disable several features of your **All-Bottle 744** or **1544** ECU. These features include such options as resetting the portion size after a pour and determining the time delay between identical pours.

Disable Unit	5-2
Enable Computer Communication	5-3
Enable Price Level Change	5-4
Reset After Pour	5-5
Server Menu Active	5-6
Restart Pour Delay	5-7

Disable Unit

To maintain system security, use this feature to prevent the pouring of any All-Bottle drinks. If you have flow meters, this feature does not prevent their use. However, while the ECU is disabled it continues to track any flow meter activity.

Available in Option Package(s): 744-Basic 744-CR AR FM ID DX

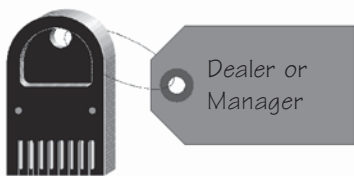

■ To disable a unit:

1. Access the Manager Menu. (Insert your key, press ENTER, select the Manager Menu option and press ENTER.)

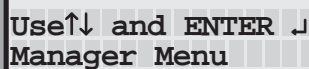
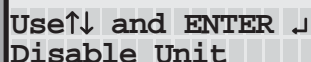
A screenshot of a digital display showing the text "Use↑↓ and ENTER ↵" on the top line and "Manager Menu" on the bottom line. The display has a grid background.A screenshot of a digital display showing the text "Use↑↓ and ENTER ↵" on the top line and "Disable Unit" on the bottom line. The display has a grid background.

2. Use the up and down arrow keys to display the **Disable Unit** option and press ENTER.

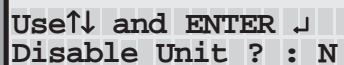
A screenshot of a digital display showing the text "Use↑↓ and ENTER ↵" on the top line and "Disable Unit ? : N" on the bottom line. The display has a grid background.

3. Use the down arrow to select **Y** (to disable the unit)) or the up arrow to select **N** (to keep the unit enabled) and press ENTER.

The display returns to the **Disable Unit** option.

If you select **Y**, as soon as you remove the Manager Key the display confirms the unit is disabled.

A screenshot of a digital display showing the text "BERG 744-DX" on the top line and "Disabled" on the bottom line. The display has a grid background.

Enable Computer Communication

This feature enables communication between an **All-Bottle 744** or **1544** ECU and a computer using the **All-Bottle Manager** software. You must enable this feature at the ECU to use the software.

Available in Option Package(s): 744-Basic 744-CR AR FM ID DX

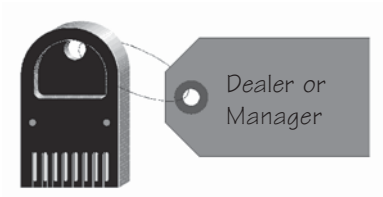

■ To enable computer communication:

1. Access the Manager Menu. (Insert your key, press ENTER, select the Manager Menu option and press ENTER.)



2. Use the up and down arrow keys to display the **Communications** option and press ENTER.

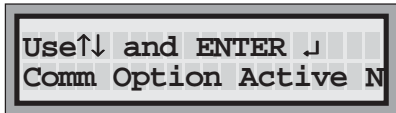

3. Use the down arrow to select **Y** (to enable communication) or the up arrow to select **N** (to disable communication) and press ENTER.

The display returns to the **Communications** option.

Notes

- If you select **Y**, no further Manager Menu or Server Menu options appear at the ECU to prevent internal conflicts while communicating with the computer.
- Pouring operations are not affected by enabling computer communication.

Enable Price Level Change

If you want to let any bartender or server change the price level at the ECU you must enable this feature. Otherwise the price level can only be changed with a manager key in the ECU's key slot.

Available in Option Package(s): 744-Basic 744-CR AR FM ID DX

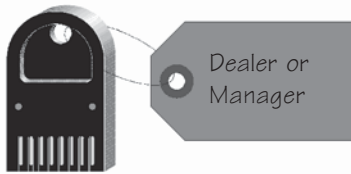

■ To enable price level change:

1. Access the Manager Menu. (Insert your key, press ENTER, select the Manager Menu option and press ENTER.)



2. Use the up and down arrow keys to display the **Price Level Change** option and press ENTER.

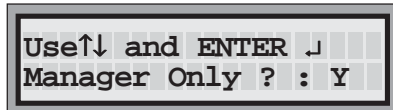

3. Use the down arrow to select **Y** (to enable price level change only by a manager) or the up arrow to select **N** (to enable price level change by any server) and press ENTER.

The display returns to the **Price Level Change** option.

Reset After Pour

If you enable the Reset After Pour feature, the portion size selected at the ECU resets to Regular after every pour. If you do not enable this feature, portion size is determined by the currently selected size until you choose a different one.

Available in Option Package(s): 744-Basic 744-CR AR FM ID DX

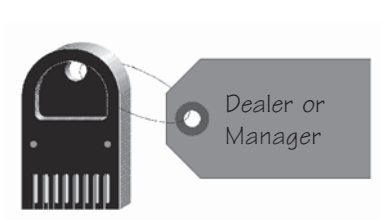

■ To enable reset after pour:

1. Access the Manager Menu. (Insert your key, press ENTER, select the Manager Menu option and press ENTER.)



2. Use the up and down arrow keys to display the **Reset After Pour** option and press ENTER.

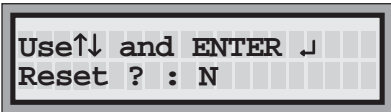

3. Use the down arrow to select **Y** (to reset portion size to Regular after every pour) or the up arrow to select **N** (to keep the current portion size after every pour) and press ENTER.

The display returns to the **Reset After Pour** option.

Server Menu Active

You can specify whether or not to give servers access to the Server Menu at the ECU. If the Server Menu is disabled, servers will not be able to view or print the X report which details their sales activities.

Available in Option Package(s): 744-Basic 744-CR AR FM ID DX

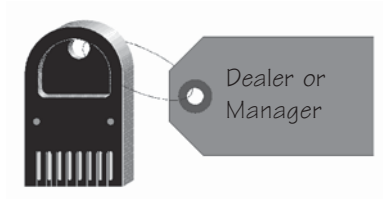

■ To enable or disable access to the Server Menu:

1. Access the Manager Menu. (Insert your key, press ENTER, select the Manager Menu option and press ENTER.)

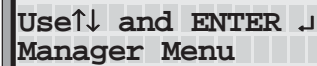
A screenshot of the Manager Menu display showing the text "Use↑↓ and ENTER ↵" on the first line and "Manager Menu" on the second line.

2. Use the up and down arrow keys to display the **Server Menu Active** option and press ENTER.

A screenshot of the Server Menu Active display showing the text "Use↑↓ and ENTER ↵" on the first line and "Server Menu Active" on the second line.

3. Use the down arrow to select **Y** (to enable access to the Server Menu) or the up arrow to select **N** (to disable access to the Server Menu) and press ENTER.

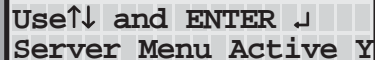
A screenshot of the Server Menu Active Y display showing the text "Use↑↓ and ENTER ↵" on the first line and "Server Menu Active Y" on the second line.

The display returns to the **Server Menu Active** option.

Note

- Even if **Server Menu Active** is set to **Y**, you will not be able to access the Server Menu if **Comm Option Active** (in the Manager Menu) is also set to **Y**.

Restart Pour Delay

You can pour repeated drinks with an All-Bottle pourer without tipping the bottle back. Restart Pour Delay specifies the number of seconds the All-Bottle pourer pauses between the end of one pour and the start of another identical one.

Available in Option Package(s): 744-Basic 744-CR AR FM ID DX

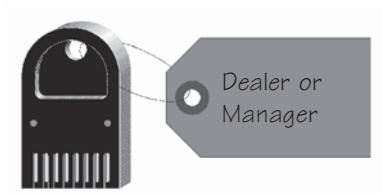

■ To set restart pour delay:

1. Access the Manager Menu. (Insert your key, press ENTER, select the Manager Menu option and press ENTER.)



2. Use the up and down arrow keys to display the **Restart Pour Delay** option and press ENTER.

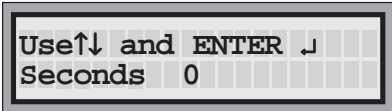

3. Use the up and down arrow keys to select the number of seconds (0 through 9) you wish the pourer to delay between repeated drinks and press ENTER.

The display returns to the **Restart Pour Delay** option.

Note

- If you select 0 seconds, no pours will repeat.

6 Calibration, Prices, Portions and PLUs

Each newly installed **All-Bottle 744** or **1544** pourer needs to be checked and adjusted for pouring accuracy. This process is called calibration. In addition, portion sizes and, depending on your option package, prices and PLUs must be entered at the ECU for each coded pourer. If your system includes flow meters, you must also enter a meter count and price per unit for each flow meter to ensure pouring accuracy.

Calibrate Coded Pourers	6-2
Define Portion Sizes	6-4
Define Prices	6-5
Define PLUs	6-6
Define Flow Meter Prices per Unit	6-7
Set Flow Meter Counts	6-8
Clear All-Bottle Prices, Portions and PLUs	6-10
Clear Flow Meter Prices	6-11
Clear All Prices, Portions and PLUs	6-12
Portion Change Lockout	6-13

Calibrate Coded Pourers

You want to be sure the amount of beverage actually poured with an All-Bottle pourer matches the amount recorded for the pour at the ECU. Calibration (checking the accuracy of the measuring process and making any necessary adjustments) needs to be performed for each of the seven or fifteen coded pourers.

Available in Option Package(s): 744-Basic 744-CR AR FM ID DX

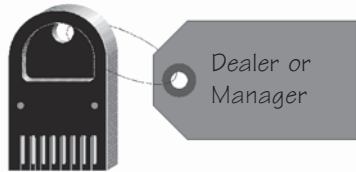

■ To calibrate a coded pourer:

1. Access the Manager Menu. (Insert your key, press ENTER, select the Manager Menu option and press ENTER.)

```
Use↑↓ and ENTER ↵
Manager Menu
```

```
Use↑↓ and ENTER ↵
Calibrate
```

2. Use the up and down arrow keys to display the **Calibrate** option and press ENTER.

```
Use↑↓ and ENTER ↵
Code 1
```

3. Use the up and down arrow keys to select the number of the coded pourer you want to calibrate and press ENTER.

```
Use ↑↓ and ENTER ↵
Code 1 1000 1000
```

You are now in calibration mode for the selected pourer. The first number listed is the current calibration number for the pourer (factory default is 670 for EPROM ver. 1.09 or higher, 1000 for EPROM ver. lower than 1.09). The second number is an entry field for you to enter a new calibration number.

4. Pour a drink with the selected pourer into a graduated cylinder.
5. Carefully measure the volume of drink poured. If the pourer is calibrated accurately, the volume poured should be 1 ounce or 30 milliliters.

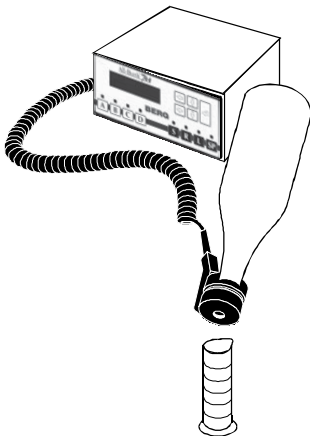

If you are not satisfied with the accuracy of the pour (the volume is not close enough to 1 ounce or 30 milliliters), proceed with step 6.

OR

If you are satisfied with the accuracy of the pour and the current calibration number, proceed with step 9.

- Calculate a new calibration number.

Divide 1 ounce or 30 milliliters (whichever is your target volume) by the amount of your test pour.

Example: 1 ounce divided by .81 ounce = 1.23

Multiply your answer by the current calibration number (the first of the two numbers on the display).

Example: 1.23 X 1000 = 1230

This is your new calibration number.

- Key in the new calibration number using the up and down arrow keys to select the numbers and the left and right arrow keys to move through the number fields and press ENTER.

```
Use ↑↓ and ENTER ↵
Code 1 1000 1230
```

The first number on the display changes to match the second number.

```
Use ↑↓ and ENTER ↵
Code 1 1230 1230
```

- Repeat steps 4-7 (pouring, measuring, recalculating) until you are satisfied with the accuracy of the selected pourer.
- Press ENTER to save the calibration number that gave you the most accuracy.

The display returns to the **Code** option.

```
Use ↑↓ and ENTER ↵
Code 1
```

- Repeat steps 3-9 for each coded pourer you want to calibrate.

Notes

- All other pourers are temporarily disabled once you are in calibration mode for a selected pourer.
- The calibration numbers for all pourers are listed at the end of the Configuration report.
- The default calibration number for high flow pourers is 670. If you use high flow pourers with EPROM ver. lower than 1.09, the default calibration number of 1000 (on the ECU display) is too high. Enter 670 as a calibration number before pouring to get a more accurate pour.
- The default calibration number for standard flow pourers is 1000. If you use standard flow pourers with EPROM ver. 1.09 or higher, the default calibration number of 670 (on the ECU display) is too low. Enter 1000 as a calibration number before pouring to get a more accurate pour.

Define Portion Sizes

You can preset four portion sizes for each price level of each coded pourer in your **All-Bottle 744** or **1544** system. Portion sizes can be as small as 1/8 ounce and as large as 10 ounces.

Available in Option Package(s): 744-Basic 744-CR AR FM ID DX

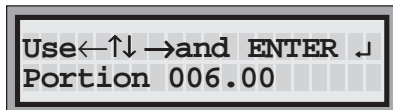
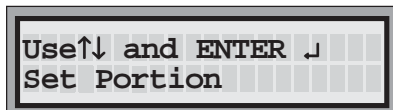
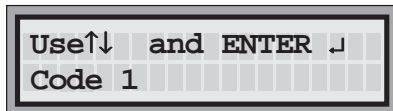
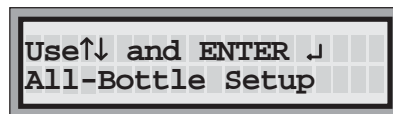
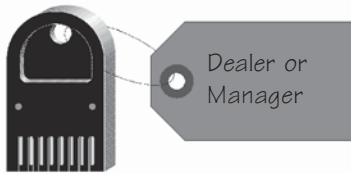

■ To define portion sizes:

1. Access the Manager Menu. (Insert your key, press ENTER, select the Manager Menu option and press ENTER.)



2. On the front panel of the ECU select a price level (A, B, C or D) and a size (S, R, L or SP).

3. Use the up and down arrow keys to display the **All-Bottle Setup** option and press ENTER.

4. Use the up and down arrow keys to select the pourer code for which you are defining portion sizes and press ENTER.

5. Use the up and down arrow keys to display the **Set Portion** option and press ENTER.

6. Key in the portion size using the up and down arrow keys (to select the numbers) and the left and right arrow keys (to move through the number fields) and press ENTER.

The display returns to the **Set Portion** option.

7. Select a new size and/or price level on the front panel of the ECU and repeat steps 5 and 6 for each portion size.

Note

- If you try to enter a portion size greater than 10 ounces (295.7 ml), or greater than 0 but less than 1/8 ounce (3.7 ml), the ECU does not accept the entry when you press the ENTER key. Select a new amount.

Define Prices

You can preset four price levels for each coded pourer in your **All-Bottle 744** or **1544** system.

Available in Option Package(s): 744-Basic 744-CR AR FM ID DX

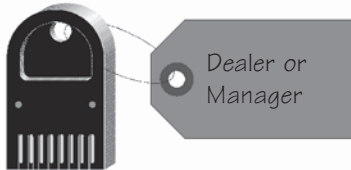

■ To define prices:

1. Access the Manager Menu. (Insert your key, press ENTER, select the Manager Menu option and press ENTER.)



2. On the front panel of the ECU select a price level (A, B, C or D) and a size (S, R, L or SP).



3. Use the up and down arrow keys to display the **All-Bottle Setup** option and press ENTER.

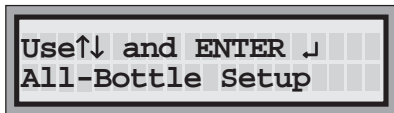

4. Use the up and down arrow keys to select the pourer code for which you are defining prices and press ENTER.



5. Use the up and down arrow keys to display the **Set Price** option and press ENTER.

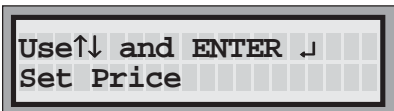

6. Key in the price using the up and down arrow keys (to select the numbers) and the left and right arrow keys (to move through the number fields) and press ENTER.

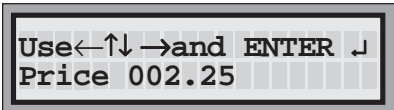

The display returns to the **Set Price** option.

7. Select a new size and/or price level on the front panel of the ECU and repeat steps 5 and 6 for each price you want to define.

Define PLUs

If you are using the ECR interface with your **All-Bottle 744** or **1544**, you must enter sales information at the ECU that the cash register needs to ring up each drink. Determine the correct PLU (price look up) for each size of drink poured at each price level by each coded pourer. These PLUs are already defined at the cash register; you just need to enter them at the ECU.

Available in Option Package(s): 744-Basic 744-CR AR FM ID DX

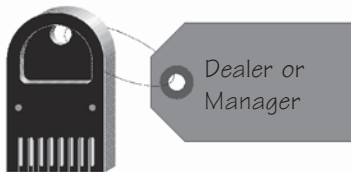

■ To define PLUs:

1. Access the Manager Menu. (Insert your key, press ENTER, select the Manager Menu option and press ENTER.)

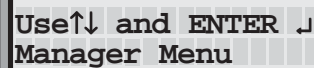

```
Use↑↓ and ENTER ↵
Manager Menu
```



2. On the front panel of the ECU select a price level (A, B, C or D) and a size (S, R, L or SP).

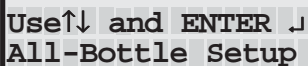

```
Use↑↓ and ENTER ↵
All-Bottle Setup
```

3. Use the up and down arrow keys to display the **All-Bottle Setup** option and press ENTER.

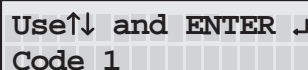

```
Use↑↓ and ENTER ↵
Code 1
```

4. Use the up and down arrow keys to select the pourer code for which you are defining PLUs and press ENTER.

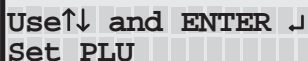

```
Use↑↓ and ENTER ↵
Set PLU
```

5. Use the up and down arrow keys to display the **Set PLU** option and press ENTER.



```
Use←↑↓→and ENTER ↵
PLU 0018
```

6. Key in the PLU using the up and down arrow keys (to select the numbers) and the left and right arrow keys (to move through the number fields) and press ENTER. The valid range of PLUs is 0 to 9999.

The display returns to the **Set PLU** option.

7. Select a new size and/or price level on the front panel of the ECU and repeat steps 5 and 6 for each PLU you want to define.

Define Flow Meter Price per Unit

If you are using flow meters, the sales for each flow meter appear on designated reports. You need to enter the price per unit of volume for each price level of each flow meter for this sales data to be calculated. The price per unit is multiplied by the total units poured by the flow meter to determine the total sales.

Available in Option Package(s): 744-Basic 744-CR AR FM ID DX

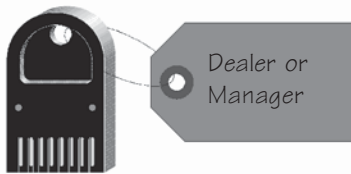

■ To define flow meter prices per unit:

1. Access the Manager Menu. (Insert your key, press ENTER, select the Manager Menu option and press ENTER.)

```
Use↑ and ENTER ↓
Manager Menu
```

```
Use↑ and ENTER ↓
Flow Meter Setup
```

2. Use the up and down arrow keys to display the **Flow Meter Setup** option and press ENTER.

```
Use↑ and ENTER ↓
Flow Meter #1
```

3. Use the up and down arrow keys to select the flow meter you want to enter a price per unit for and press ENTER.

```
Use↑ and ENTER ↓
Set Price/Unit Lvl A
```

4. Use the up and down arrow keys to display the **Set Price/Unit** option.

```
Use↑ and ENTER ↓
Set Price/Unit Lvl B
```

5. Use the down arrow key to select the price level (**Lvl A, B, C** or **D**) for which you're defining a price per unit and press ENTER.

```
Use←↑→and ENTER ↓
Price/Unit 001.00
```

6. Key in the price per unit using the up and down arrow keys (to select the numbers) and the left and right arrow keys (to move through the number fields) and press ENTER.

The display returns to the **Set Price/Unit** option.

7. Repeat steps 5 and 6 for each price level of a selected flow meter.
8. Use the up arrow to select the **Exit This Menu** option and press ENTER. Repeat steps 3-7 for each additional flow meter.

Note

- The volume unit (oz, ml, cc, cl or L) you are defining a price for is the one currently selected at the ECU.

Set Flow Meter Counts

If you are using flow meters with your **All-Bottle 744** or **1544**, you must check the accuracy of their measurements and adjust the flow meter counts if necessary. (The flow meter count is the number of counts from the flow meter per ounce of beverage multiplied by 100.) It's the number you recorded and saved at the time of flow meter installation.

Available in Option Package(s): 744-Basic 744-CR AR FM ID DX

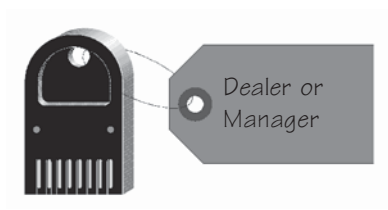

■ To set flow meter counts:

1. Access the Manager Menu. (Insert your key, press ENTER, select the Manager Menu option and press ENTER.)

```
Use↑↓ and ENTER ↵
Manager Menu
```

2. Run a Z report to clear all sales. See the *Reports* section.

3. Use the up and down arrow keys to display the **Flow Meter Setup** option and press ENTER.

```
Use↑↓ and ENTER ↵
Flow Meter Setup
```

4. Use the up and down arrow keys to select the number of the flow meter for which you'll enter a meter count and press ENTER.

```
Use ↑↓ and ENTER ↵
Flow Meter #1
```

5. Use the up and down arrow keys to display the **Meter Count** option and press ENTER.

```
Use↑↓ and ENTER ↵
Meter Count
```

6. Key in the meter count using the up and down arrow keys (to select the numbers) and the left and right arrow keys (to move through the number fields) and press ENTER.

```
Use←↑↓→and ENTER ↵
3614
```

Use the number you recorded from the flow meter at the time of installation or a default meter count of 3614.

The display returns to the **Meter Count** option.

7. Pour a drink (using the selected flow meter) of approximately 16 ounces and measure the exact amount poured. Be as accurate as possible.

8. Run a sales report (Detailed X or Z is probably best) to learn the recorded volume of the test pour.

If you are not satisfied with the accuracy of the pour (the volume you measured is not close enough to the volume recorded on the report), proceed with step 9.

OR

If you are satisfied with the accuracy of the pour and the current flow meter count, proceed with step 11.

9. Calculate a new flow meter count to enter.

Divide the amount of the test pour given in the report by the amount you measured.

Example: 16.65 ounces divided by 17.2 ounces = .968

Multiply your answer by the current meter count.

Example: .968 X 3614 = 3498

This is your new flow meter count.

10. Repeat steps 2-10 (clearing sales or choosing a new price level with no sales, entering a meter count, pouring, measuring) until you are satisfied with the accuracy of the selected flow meter.
11. Perform all the steps of this task for each flow meter installed in your system.

Clear All-Bottle Prices, Portions and PLUs

When you need to reassign All-Bottle prices, portion sizes and PLUs, use this feature to quickly clear the current settings.

Available in Option Package(s): 744-Basic 744-CR AR FM ID DX

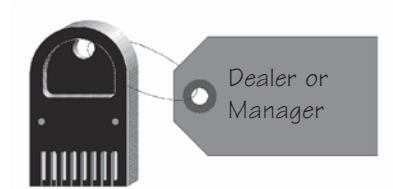

■ To clear prices, portions and PLUs:

1. Access the Manager Menu. (Insert your key, press ENTER, select the Manager Menu option and press ENTER.)

```
Use↑↓ and ENTER ↵
Manager Menu
```

```
Use↑↓ and ENTER ↵
Clear Price/Por/PLUs
```

2. Use the up and down arrow keys to display the **Clear Price/Por/PLUs** option and press ENTER.

```
Use↑↓ and ENTER ↵
All-Bottle Data
```

3. Use the up and down arrow keys to display the **All-Bottle Data** option and press ENTER.

```
Use↑↓ and ENTER ↵
Clear Settings ? : Y
```

4. Use the down arrow key to select **Y** (to clear prices, portion sizes and PLUs) or use the up arrow key to select **N** (to keep the current prices, portion sizes and PLUs) and press ENTER.

The display returns to the **All-Bottle Data** option.

Note

- If you have option package **FM** or **DX**, you can choose to clear your All-Bottle settings (price, portion and PLU) or your flow meter settings (price per unit) or both. See *Clear Flow Meter Prices* and *Clear All Prices, Portions and PLUs* in this section.

Clear Flow Meter Prices

If you have flow meters, you can quickly reset the price per unit to zero for all flow meters at the same time.

Available in Option Package(s): 744-Basic 744-CR AR FM ID DX

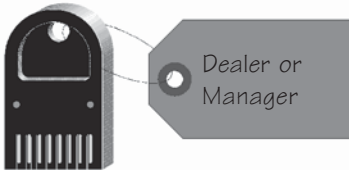

■ To clear flow meter prices:

1. Access the Manager Menu. (Insert your key, press ENTER, select the Manager Menu option and press ENTER.)

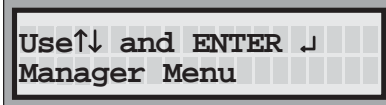

2. Use the up and down arrow keys to display the **Clear Price/Por/PLUs** option and press ENTER.



3. Use the up and down arrow keys to display the **Flow Meter Prices** option and press ENTER.



4. Use the down arrow key to select **Y** (to clear flow meter prices) or use the up arrow key to select **N** (to keep the current flow meter prices) and press ENTER.

The display returns to the **Flow Meter Prices** option.

Note

- If you have option package **FM** or **DX**, you can choose to clear your All-Bottle settings (price, portion and PLU) or your flow meter settings (price per unit) or both. See *Clear All-Bottle Prices, Portions and PLUs* and *Clear All Prices, Portions and PLUs* in this section.

Clear All Prices, Portions and PLUs

If you have flow meters, you can quickly clear both your All-Bottle settings and your flow meter prices using this feature.

Available in Option Package(s): 744-Basic 744-CR AR FM ID DX

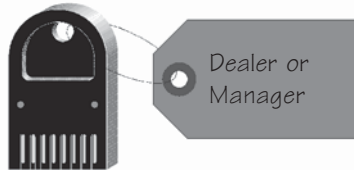

■ To clear all prices, portions and PLUs:

1. Access the Manager Menu. (Insert your key, press ENTER, select the Manager Menu option and press ENTER.)

```
Use↑ and ENTER ↓
Manager Menu
```

```
Use↑ and ENTER ↓
Clear Price/Por/PLUs
```

2. Use the up and down arrow keys to display the **Clear Price/Por/PLUs** option and press ENTER.

```
Use↑ and ENTER ↓
All Price/Por/PLUs
```

3. Use the up and down arrow keys to display the **All Price/Por/PLUs** option and press ENTER.

```
Use↑ and ENTER ↓
Clear All Data? : Y
```

4. Use the down arrow key to select **Y** (to clear all price, portion and PLU data) or use the up arrow key to select **N** (to keep the current data) and press ENTER.

The display returns to the **All Price/Por/PLUs** option.

Note

- If you have option package **FM** or **DX**, you can choose to clear your All-Bottle settings (price, portion and PLU) or your flow meter settings (price per unit) or both. See *Clear All-Bottle Prices, Portions and PLUs* and *Clear Flow Meter Prices* in this section.

Portion Change Lockout

A jumper can be installed in the ECU to disable any portion size changes once measurements have been inspected. After the jumper is installed, no one can clear or change portion sizes until the jumper is removed.

Available in Option Package(s): 744-Basic 744-CR AR FM ID DX

■ To install a portion change lockout jumper:

1. Set up and program the desired portion sizes, but do not mount the ECU at this time.
2. Check the portion sizes by pouring a portion from each pourer price category and verify that the correct amount was dispensed.
3. Unplug and disconnect all cables to the back of the ECU.
4. Loosen the two screws on each side of the ECU with a hex wrench. Loosen the stand off nuts on the back of the ECU with a nut driver. Open the bottom of the ECU.
5. Locate connector J9 on the system board. Install the portion change lockout jumper (Berg PN 8007294) so that the two pins are shorted together.
6. Replace the cover on the ECU and tighten the four screws that secure it and the stand off nuts on the back of the ECU.
7. Reconnect all cables and plug in the ECU.
8. Mount the ECU in the desired location.

Note

- See the diagram of the ECU on the next page.

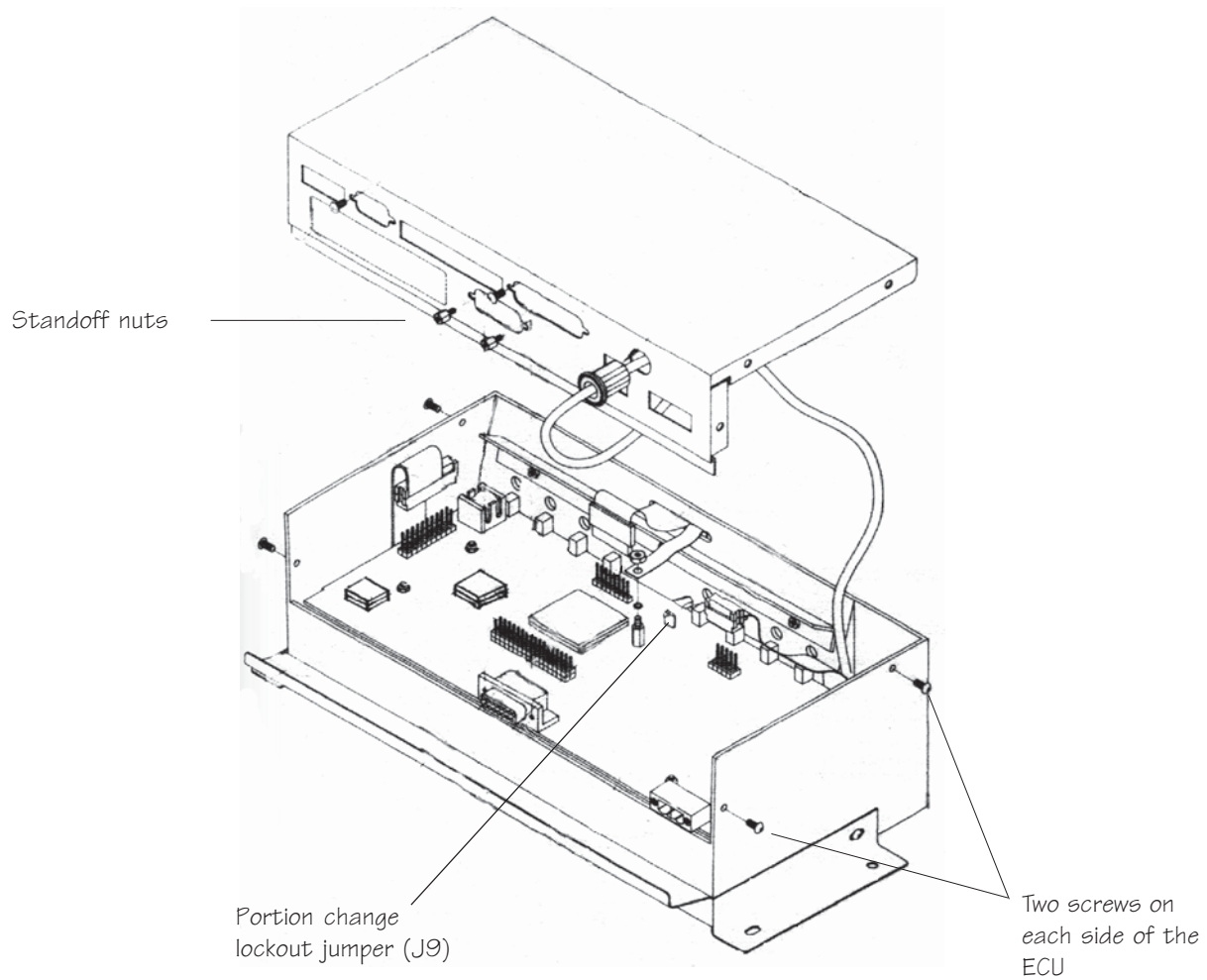

Caution:

Electronic components are sensitive to static electricity. If possible, avoid working on the **744** or **1544** ECU while standing on a carpeted surface. Before you open the **744** or **1544** ECU, discharge any static electricity from your body by touching any known grounded metal surface. Also discharge the static repeatedly in like manner while working on the ECU.

SECTION

7

All-Bottle Pouring

Once your **All-Bottle 744** or **1544** system is installed, you're ready to begin pouring. This section provides help with the following tasks:

Pour a Drink	7-2
Repeat a Pour	7-3
Pour with Server ID	7-4
Pour with Flow Meters and Server ID	7-6

Pour a Drink

You can pour four different portion sizes at four price levels for each of the seven or fifteen **All-Bottle 744** or **1544** coded pourers.

Available in Option Package(s): 744-Basic 744-CR AR FM ID DX



■ To pour a drink:

1. Verify the correct price level button (A, B, C or D) is lit on the front panel of the ECU.

If you need to change the price level, press a new button (A, B, C or D).

If you have enabled "manager only" price level change, you must insert a manager key in the ECU key slot to change the price level. (See *Enable Price Level Change* in the *Pouring Control* section.)



2. Select the desired portion size by pressing the S (small), R (regular), L (large) or SP (special) button on the ECU's front panel. Verify the correct portion size button is lit.
3. Pick up a bottle with a secured pourer and insert the pourer into the activator ring (located in the ring holder).
4. Grasp the finger grip on the activator ring with your index finger and quickly invert the bottle to a near vertical pouring position over a glass.

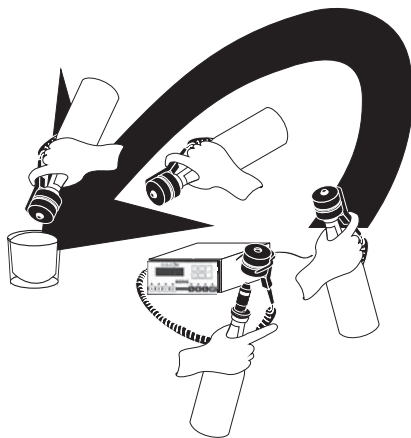

The pour commences. The ECU window displays the code number of the pourer.



Berg 744-DX
Code 1

5. When the pour ends, tip the bottle back to an upright position. Return the activator ring to the ring holder and the bottle to its prior location.

Notes

- If the pour does not immediately begin, quickly tip the bottle and activator ring to an upright position and then back to a vertical pouring position over the glass.
- If the pour splashes sideways and misses the glass, you may not have tipped the bottle to a vertical position quickly enough.

Repeat a Pour

If you need to pour identical drinks, the **All-Bottle 744** or **1544** pourers can be enabled to restart pouring without tipping them back.

Available in Option Package(s): 744-Basic 744-CR AR FM ID DX

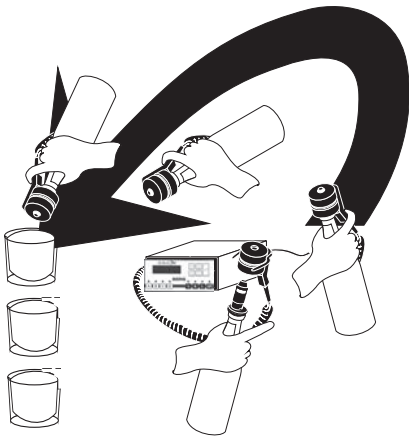

■ To pour two or more identical drinks:

1. Verify the correct price level button (A, B, C or D) is lit on the front panel of the ECU.

If you need to change the price level, press a new button.

If you have enabled "manager only" price level change, you must insert a manager key to change the price level. (See *Enable Price Level Change* in the *Pouring Control* section.)

2. Select the desired portion size by pressing the S (small), R (regular), L (large) or SP (special) button on the ECU's front panel. Verify the correct portion size button is lit.
3. Pick up a bottle with a secured pourer and insert the pourer into the activator ring (located in the ring holder).
4. Grasp the finger grip on the activator ring with your index finger and quickly invert the bottle to a near vertical pouring position over a glass.

The pour commences. The ECU window displays the code number of the pourer.

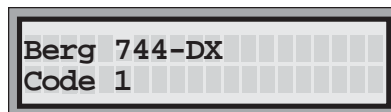

5. When the pour ends, quickly position the bottle over a new glass (still holding the bottle in a vertical pouring position). You have 1-9 seconds before a new pour commences.
6. Repeat step 5 for as many identical drinks as you need.
7. Tip the bottle back to an upright position. Return the activator ring to the ring holder and the bottle to its prior location.

Note

- The restart pour delay is determined in the Manager Menu at the ECU. See *Restart Pour Delay* in the *Pouring Control* section.

Pour with Server ID

If you have installed option package **ID** or **DX**, pouring can not take place without a server key in either the ECU's key slot or the remote server access box. The name assigned to the key in the slot must also match a name in the current Key Assignment list.

Available in Option Package(s): 744-Basic 744-CR AR FM ID DX



■ To pour with server ID:

1. Verify the correct price level button (A, B, C or D) is lit on the front panel of the ECU.

If you need to change the price level, press a new button (A, B, C or D).

If you have enabled "manager only" price level change, you must insert a manager key in the ECU key slot to change the price level. (See *Enable Price Level Change* in the *Pouring Control* section.)

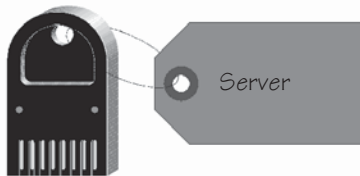

2. Insert your server key in the ECU or the remote server access box.

The name assigned to the key appears in the ECU display window.



Berg 744-ID
MIKE



3. Select the desired portion size by pressing the S (small), R (regular), L (large) or SP (special) button on the ECU's front panel. Verify the correct portion size button is lit.

4. Pick up a bottle with a secured pourer and insert the pourer into the activator ring (located in the ring holder).
5. Grasp the finger grip on the activator ring with your index finger and quickly invert the bottle to a near vertical pouring position over a glass.

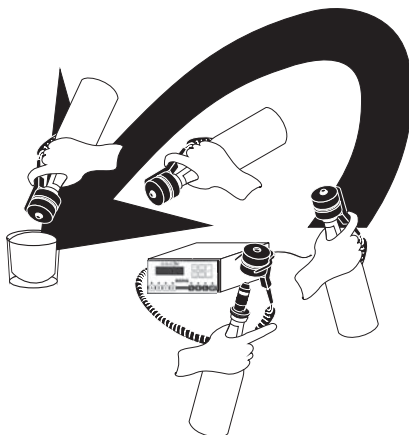

The pour commences and the ECU window displays the code number of the pourer in addition to the name assigned to the server key.



Berg 744-ID
Code 1 MIKE

5. Wait for the pour to end.
8. Tip the bottle back to an upright position. Return the activator ring to the ring holder and the bottle to its prior location.
9. Remove your server key from the key slot.

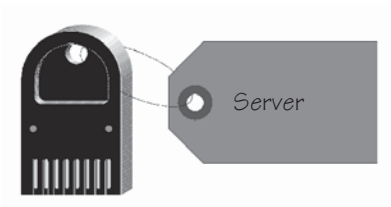

Note

- If another key is in the ECU front key slot, the ECU reads "Both Keys" and pouring is disabled.

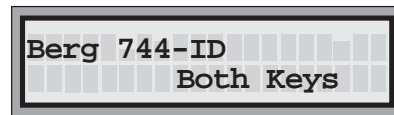

Pour with Flow Meters and Server ID

If you have installed option package **DX** with both flow meters and server ID, all pours with the flow meters will be assigned to the server whose key is in either the ECU or the remote server access box at the time of pouring.

Available in Option Package(s): 744-Basic 744-CR AR FM ID DX



■ To pour with flow meters and server ID:

1. Verify the correct price level button (A, B, C or D) is lit on the front panel of the ECU.

If you need to change the price level, press a new button (A, B, C or D).

If you have enabled "manager only" price level change, you must insert a manager key in the ECU key slot to change the price level. (See *Enable Price Level Change* in the *Pouring Control* section.)

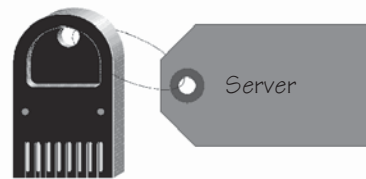

2. Insert your server key in the ECU or the remote server access box.

The name assigned to the key appears in the ECU display window.

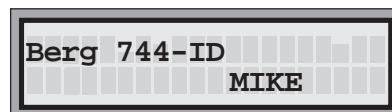

3. Pour a drink from the faucet or tap connected to the flow meter line.
4. Remove your server key from the key slot.

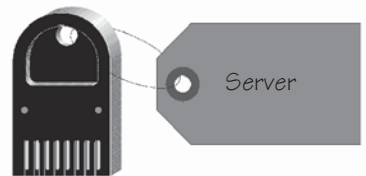

Notes

- If there is a server key in both key slots (ECU and remote server access box), any flow meter pours are assigned to the server whose key is in the remote server access box.
- If there are no keys in either slot at the time of a flow meter pour, the sales are listed on reports as "unassigned flow meter sales". To prevent flow meter pouring without a key in the system, see *Connect an External Solenoid Output* in the *Hardware Installation* section.

8 Reports

If you are using Advanced Reporting with your **All-Bottle 744** or **1544**, a variety of reports are available for your use. These reports can be sent directly from the ECU to a printer or computer. If you are also using Server ID, you can generate specific reports on the activity of each server in addition to total sales reports.

Summary Reports (X and Z)	8-2
Detailed Reports (X and Z)	8-4
Last Z Report	8-6
Hourly Sales Report	8-8
Price Level Change Report	8-10
Configuration Report	8-12
Price/Portion Report	8-14
PLU Report	8-16
All Server Summary Reports (X and Z)	8-18
Individual Server Summary Reports (X and Z)	8-20
Individual Server Reports Using the Server Menu	8-22
Clear Cumulative Sales	8-24

Summary Reports (X and Z)

Summary reports provide the total number of pours and the total sales for each price level. (The sales from all seven or fifteen bottle codes are combined.) If you have flow meters, the total volume and total sales for three flow meters at all four price levels is provided. Summary X and Z reports are exactly the same—but a Z report zeros out your sales totals.

Available in Option Package(s): 744-Basic 744-CR AR FM ID DX

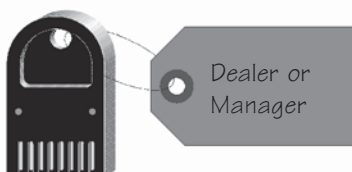

■ To generate a summary X or Z report

1. Access the Manager Menu. (Insert your key, press ENTER, select the Manager Menu option and press ENTER.)

```
Use↑↓ and ENTER ↵
Manager Menu
```

```
Use↑↓ and ENTER ↵
View Reports
```

```
Use↑↓ and ENTER ↵
Summary X
```

```
Creating Report,
Please Wait
```

```
←=Exit      →=Print
Use↑ and↓   to view
```

2. Use the up and down arrow keys to display the **View Reports** option and press ENTER.
3. Use the up and down arrow keys to select the **Summary Z** option or the **Summary X** option and press ENTER.
4. Wait for the report to be generated.
5. View the report from the display using the up and down arrow keys. Press ENTER to quit viewing.

If you have option package **AR**, **FM**, **ID** or **DX**, use the right arrow key to print the report.

6. Use the left arrow key to exit the report.

Notes

- If you have option package **Basic** or **CR**, summary reports show the number of portions poured without any sales data.
- If you have option package **ID** or **DX**, a Z report clears all individual server sales data. A warning reminds you. (Run a server report first if you want to save the server data.)
- The Z number is the number of summary Z or detailed Z reports that have been run. You can detect any unauthorized use of Z reports if you know what this number should be.

Berg All-Bottle 744 Summary X Report

Station 1 Date: 04/23/96 Time: 09:49:00 PM

All-Bottle Sales

	Portions	Sales
Price Level A	52	143.50
Price Level B	114	329.75
Price Level C	88	266.25
Price Level D	160	387.50
Totals	414	1127.00

Flow Meter Sales

	Volume (oz)	Sales
Price Level A	2352.57	159.00
Price Level B	918.86	81.00
Price Level C	2795.16	166.00
Price Level D	5651.73	332.00
Totals	11718.32	738.00

Report Total Sales 1865.00

Cumulative Sales 3349.75

Detailed Reports (X and Z)

Detailed X and Z reports provide the total number of pours and the total sales for each of the seven or fifteen price codes at four price levels and four portion sizes. If you have flow meters, the total volume and total sales for three flow meters at all four price levels is provided. Detailed X and Z reports are exactly the same--but a Z report zeros out your sales totals.

Available in Option Package(s): 744-Basic 744-CR AR FM ID DX

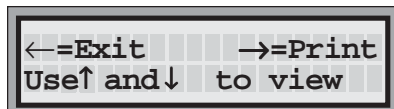
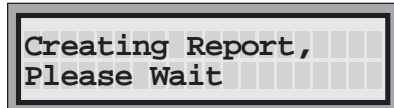
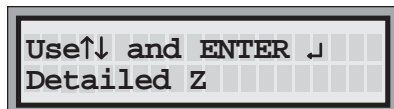
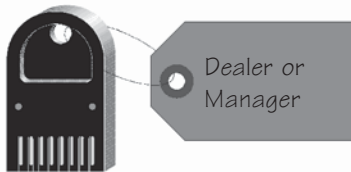

■ To generate a detailed X or Z report

1. Access the Manager Menu. (Insert your key, press ENTER, select the Manager Menu option and press ENTER.)

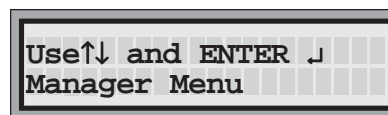

2. Use the up and down arrow keys to display the **View Reports** option and press ENTER.
3. Use the up and down arrow keys to select the **Detailed Z** option or the **Detailed X** option and press ENTER.
4. Wait for the report to be generated.
5. If you have option package **Basic** or **CR**, view the report from the display using the up and down arrow keys. Press ENTER to quit viewing.

If you have option package **AR**, **FM**, **ID** or **DX**, use the right arrow key to print the report.



6. Use the left arrow key to exit the report.

Notes

- If you have option package **Basic** or **CR**, detailed reports show the number of portions poured without any sales data.
- If you have option package **ID** or **DX**, a Z report clears all individual server sales data. A warning reminds you. (Run a server report first if you want to save the server data.)
- The Z number is the number of summary Z or detailed Z reports that have been run. You can detect any unauthorized use of Z reports if you know what this number should be.

Berg All-Bottle 744 Detailed Z Report

Station 1 Date: 05/16/97 Time: 10:57:06 PM

Z Number 5

Price Level A

Code	Small		Regular		Large		Special	
	Portions	Sales	Portions	Sales	Portions	Sales	Portions	Sales
Code 1	7	12.00	23	46.00	15	33.75	10	30.00
Code 2	3	7.50	16	36.00	8	20.00	5	15.00
Code 3	3	8.25	8	24.00	5	15.00	3	9.00
Code 4	6	12.00	10	22.50	4	10.00	6	18.00
Code 5	3	7.50	5	10.00	3	6.75	4	12.00
Code 6	2	5.50	4	10.00	5	15.00	2	6.00
Code 7	1	2.00	2	4.50	3	7.50	3	9.00
Totals	25	54.75	68	153.00	43	108.00	33	99.00

Total Sales Price Level A 414.75

Price Level B

Code	Small		Regular		Large		Special	
	Portions	Sales	Portions	Sales	Portions	Sales	Portions	Sales
Code 1	8	14.00	25	56.00	15	33.75	13	39.00
Code 2	6	15.00	16	36.00	9	22.50	4	12.00
Code 3	5	12.25	8	24.00	7	21.00	3	9.00
Code 4	6	12.00	11	25.00	4	10.00	5	15.00
Code 5	4	10.00	6	12.00	4	9.75	4	12.00
Code 6	2	5.50	4	10.00	6	18.00	5	15.00
Code 7	3	6.00	3	6.75	5	12.50	6	18.00
Totals	34	74.75	73	169.75	50	127.50	40	120.00

Flow Meter #1 Totals oz 132.08 Sales 46.23
 Flow Meter #2 Totals oz 257.06 Sales 128.53
 Flow Meter #3 Totals oz 489.08 Sales 220.08

Total Sales Price Level B 886.84

Report Total Sales 1301.59

Cumulative Sales 7883.24

Unassigned Flow Meter Sales

Price Level A
 No Activity

Price Level B
 Flow Meter #1 Totals oz 32.08 Sales 11.23
 Flow Meter #3 Totals oz 48.32 Sales 21.75

Price Level C
 No Activity

Price Level D
 No Activity

Last Z Report

A last Z report is a backup copy of the most recent Z report generated. This includes summary Z, detailed Z, all server summary Z and individual server summary Z reports. A last Z report does not clear any sales totals because it is not a current Z report.

Available in Option Package(s): 744-Basic 744-CR AR FM ID DX

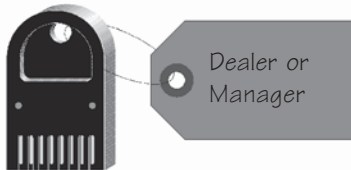

■ To generate a last Z report

1. Access the Manager Menu. (Insert your key, press ENTER, select the Manager Menu option and press ENTER.)

```
Use↑↓ and ENTER ↵
Manager Menu
```

```
Use↑↓ and ENTER ↵
View Reports
```

2. Use the up and down arrow keys to display the **View Reports** option and press ENTER.

```
Use↑↓ and ENTER ↵
Last Z
```

3. Use the up and down arrow keys to select the **Last Z** option and press ENTER.

```
Creating Report,
Please Wait
```

4. Wait for the report to be generated.

```
←=Exit      →=Print
Use↑ and↓   to view
```

5. If you have option package **Basic** or **CR**, view the report from the display using the up and down arrow keys. Press ENTER to quit viewing.

If you have option package **AR**, **FM**, **ID** or **DX**, view a summary Z or individual server summary Z report from the display using the up and down arrow keys. Use the right arrow key to print the report. Detailed Z and all server summary Z reports are printer only reports.

```
Detailed Z
Printer-Only Report
```

6. Use the left arrow key to exit the report.

Berg All-Bottle 744 Summary Z Report

Station 1 Date: 05/16/97 Time: 10:56:11 PM
Z Number 5

All-Bottle Sales

	Portions	Sales
Price Level A	169	414.75
Price Level B	197	886.84
Price Level C	0	0.00
Price Level D	0	0.00
Totals	366	1301.59

Flow Meter Sales

	Volume (oz)	Sales
Price Level A	0.00	0.00
Price Level B	80.40	32.98
Price Level C	0.00	0.00
Price Level D	0.00	0.00
Totals	80.40	32.98

Report Total Sales 1301.59

Cumulative Sales 7883.24

Unassigned Flow Meter Sales

	Volume (oz)	Sales
Price Level A	0.00	0.00
Price Level B	80.40	32.98
Price Level C	0.00	0.00
Price Level D	0.00	0.00
Totals	80.40	32.98

Hourly Sales Report

The hourly sales report shows the sales activity for each of the previous forty-eight hours with pouring activity, including the current hour. It provides the total number of All-Bottle pours and a sales total for each hour. If you have flow meters, the hourly sales report provides the total flow meter volume and sales for each hour. The hourly sales data is cleared whenever a summary Z or detailed Z report is generated.

Available in Option Package(s): 744-Basic 744-CR AR FM ID DX

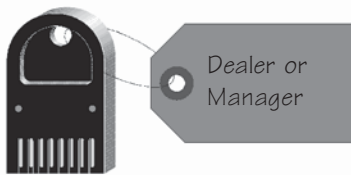

■ To generate an hourly sales report

1. Access the Manager Menu. (Insert your key, press ENTER, select the Manager Menu option and press ENTER.)

```
Use↑ and ENTER ↓
Manager Menu
```

```
Use↑ and ENTER ↓
View Reports
```

2. Use the up and down arrow keys to display the **View Reports** option and press ENTER.

```
Use↑ and ENTER ↓
Hourly Sales
```

3. Use the up and down arrow keys to select the **Hourly Sales** option and press ENTER.

```
Creating Report,
Please Wait
```

4. Wait for the report to be generated.

```
←=Exit      →=Print
Use↑ and↓ to view
```

5. Use the right arrow key to print the report or the left arrow key to exit the report. The hourly sales report is a printer only report.

```
Hourly Sales Report
Printer-Only Report
```

Berg All-Bottle 744 Hourly Sales Report

Station 1 Date: 11/12/96 Time: 12:07:53 AM

Start Time	All-Bottle		Flow Meter		Total Sales
	Portions	Sales	oz	Sales	
11/11/96 08:00:00 PM	43	53.75	0.00	0.00	53.75
11/11/96 09:00:00 PM	83	231.88	0.00	0.00	231.88
11/11/96 10:00:00 PM	59	115.32	0.00	0.00	115.32
Total Sales	126	285.63	0.00	0.00	400.95

Price Level Change Report

The price level change report shows the ten most recent price level changes made at the ECU. The exact time of each price level change is listed along with a record of the old and new price levels.

Available in Option Package(s): 744-Basic 744-CR AR FM ID DX

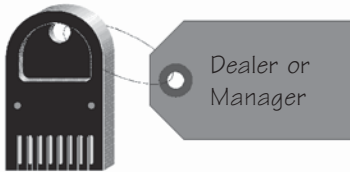

■ To generate a price level change report

1. Access the Manager Menu. (Insert your key, press ENTER, select the Manager Menu option and press ENTER.)

```
Use↑ and ENTER ↓
Manager Menu
```

```
Use↑ and ENTER ↓
View Reports
```

2. Use the up and down arrow keys to display the **View Reports** option and press ENTER.

```
Use↑ and ENTER ↓
Price Level Change
```

3. Use the up and down arrow keys to select the **Price Level Change** option and press ENTER.

```
Creating Report,
Please Wait
```

4. Wait for the report to be generated.

```
←=Exit      →=Print
Use↑ and ↓  to view
```

5. Use the right arrow key to print the report or the left arrow key to exit the report. The price level change report is a printer only report.

```
Price Level Change
Printer-Only Report
```

Berg All-Bottle 744 Price Level Change Report

Station 1 Date: 05/01/96 Time: 08:04:26 PM

Date	Time	Old Price Level	New Price Level
04/26/96	04:03:52 PM	Price Level D	Price Level A
04/26/96	06:00:02 PM	Price Level A	Price Level B
04/27/96	05:01:23 PM	Price Level B	Price Level C
04/28/96	01:30:44 PM	Price Level C	Price Level D
04/28/96	04:00:13 PM	Price Level D	Price Level A
04/28/96	06:30:55 PM	Price Level A	Price Level B
04/30/96	09:06:12 PM	Price Level B	Price Level C
05/01/96	11:03:42 AM	Price Level C	Price Level D
05/01/96	05:02:38 PM	Price Level D	Price Level A
05/01/96	07:10:29 PM	Price Level A	Price Level B

Configuration Report

The configuration report provides a list of the current settings for several options available at the ECU. It shows which pouring control options are currently enabled, the Z number, price, time and date formats, serial port settings and the calibration counts for the seven or fifteen coded pourers. If you have option package **ID** or **DX**, it lists the current servers and the number of times each server's sales data has been cleared.

Available in Option Package(s): 744-Basic 744-CR AR FM ID DX

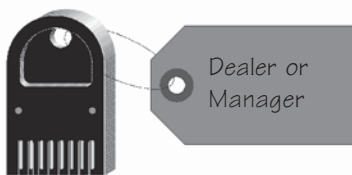

■ To generate a configuration report

1. Access the Manager Menu. (Insert your key, press ENTER, select the Manager Menu option and press ENTER.)

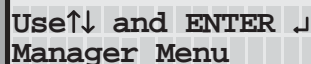
A terminal screen showing the text "Use↑ and ENTER ↓" on the first line and "Manager Menu" on the second line. The screen has a grid background.A terminal screen showing the text "Use↑ and ENTER ↓" on the first line and "View Reports" on the second line. The screen has a grid background.

2. Use the up and down arrow keys to display the **View Reports** option and press ENTER.

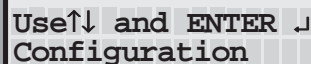
A terminal screen showing the text "Use↑ and ENTER ↓" on the first line and "Configuration" on the second line. The screen has a grid background.

3. Use the up and down arrow keys to select the **Configuration** option and press ENTER.

A terminal screen showing the text "Creating Report," on the first line and "Please Wait" on the second line. The screen has a grid background.

4. Wait for the report to be generated.

A terminal screen showing the text "←=Exit" on the first line, "→=Print" on the second line, and "Use↑ and ↓ to view" on the third line. The screen has a grid background.

5. Use the up and down arrow keys to view the report from the display. Press ENTER to quit viewing.

If you have option package **AR**, **FM**, **ID** or **DX**, use the right arrow key to print the report.

6. Use the left arrow key to exit the report.

Note

- It's a good idea to keep a copy of the current configuration report in a safe place.

Berg All-Bottle 744 Configuration Report

Station 1 Date: 04/23/96 Time: 09:05:47 PM

EPROM Version 1.09
 Disable Unit N
 Price Level Change Manager Only Y
 Reset After Pour Y
 Server Menu Active Y
 Linefeeds to Printer Y
 Enable OFF Signal Y
 Restart Pour Delay (seconds) 2
 Current Price Level Price Level B
 Z Number 4
 Price Format 999.99
 Decimal Char. Period
 Volume Units oz
 Date Format MM/DD/YY
 Time Format 12 hour
 Baud Rate 19200
 Parity No Parity
 Word Length 8-bits
 Stop Bits 1 Stop Bit

Servers

Alice	Z Number	3		
Mike	Z Number	3	Ron	Z Number
3				
Julie	Z Number	3		

Calibration Data

Code 1	959
Code 2	1028
Code 3	1107
Code 4	989
Code 5	1056
Code 6	971
Code 7	1036

Price/Portion Report

The price/portion report provides a copy of the current portion sizes and price settings for each of the seven or fifteen coded pourers at all four price levels. If you have flow meters, it also provides the flow meter count number and the price per unit of volume.

Available in Option Package(s): 744-Basic 744-CR AR FM ID DX

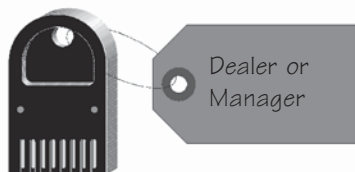

```
Use↑↓ and ENTER ↵
View Reports
```

```
Use↑↓ and ENTER ↵
Price/Portion
```

```
Creating Report,
Please Wait
```

```
←=Exit      →=Print
Use↑ and↓ to view
```

■ To generate a price/portion report

1. Access the Manager Menu. (Insert your key, press ENTER, select the Manager Menu option and press ENTER.)

```
Use↑↓ and ENTER ↵
Manager Menu
```

2. Use the up and down arrow keys to display the **View Reports** option and press ENTER.

3. Use the up and down arrow keys to select the **Price/Portion** option and press ENTER.

4. Wait for the report to be generated.

5. If you have option package **Basic** or **CR**, view the report from the display using the up and down arrow keys. Press ENTER to quit viewing.

If you have option package **AR**, **FM**, **ID** or **DX**, use the right arrow key to print the report. The price/portion report is a printer only report.

```
Price/Portion Report
Printer-Only Report
```

6. Use the left arrow key to exit the report.

Notes

- If you have option package **Basic** or **CR**, the price/portion report lists only portion sizes.
- It's a good idea to keep a copy of the current price/portion report in a safe place.

Berg All-Bottle 744 Price/Portion Report

Station 1 Date: 07/18/96 Time: 10:47:50 PM

Price Level A

Code	Small		Regular		Large		Special	
	Size	Price	Size	Price	Size	Price	Size	Price
Code 1	2.00	1.00	4.00	1.75	6.00	2.75	3.50	1.50
Code 2	2.00	1.25	4.00	2.00	6.00	3.00	3.50	1.75
Code 3	2.00	1.50	4.00	2.25	6.00	3.25	3.50	2.00
Code 4	2.00	1.00	4.00	1.75	6.00	2.75	3.50	1.50
Code 5	2.00	1.25	4.00	2.25	6.00	3.00	3.50	1.75
Code 6	2.00	1.25	4.00	2.25	6.00	3.00	3.50	2.00
Code 7	2.00	1.25	4.00	2.25	6.00	3.00	3.50	2.00

Flow Meter #1 Price/oz Price Level A 0.30
 Flow Meter #2 Price/oz Price Level A 0.25
 Flow Meter #3 Price/oz Price Level A 1.00

Price Level B

Code	Small		Regular		Large		Special	
	Size	Price	Size	Price	Size	Price	Size	Price
Code 1	2.00	1.00	4.00	2.00	6.00	3.00	3.50	1.75
Code 2	2.00	1.25	4.00	2.25	6.00	3.25	3.50	2.00
Code 3	2.00	1.50	4.00	2.50	6.00	3.50	3.50	2.25
Code 4	2.00	1.00	4.00	2.00	6.00	3.00	3.50	1.75
Code 5	2.00	1.25	4.00	2.25	6.00	3.25	3.50	2.00
Code 6	2.00	1.25	4.00	2.25	6.00	3.25	3.50	2.00
Code 7	2.00	1.25	4.00	2.25	6.00	3.25	3.50	2.00

Flow Meter #1 Price/oz Price Level B 0.40
 Flow Meter #2 Price/oz Price Level B 0.35
 Flow Meter #3 Price/oz Price Level B 1.25

Price Level C

Code	Small		Regular		Large		Special	
	Size	Price	Size	Price	Size	Price	Size	Price
Code 1	2.00	1.25	4.00	2.25	6.00	3.25	3.50	2.00
Code 2	2.00	1.50	4.00	2.50	6.00	3.50	3.50	2.25
Code 3	2.00	1.75	4.00	2.75	6.00	3.75	3.50	2.50
Code 4	2.00	1.25	4.00	2.25	6.00	3.25	3.50	2.00



Price Level D

Code	Small		Regular		Large		Special	
	Size	Price	Size	Price	Size	Price	Size	Price
Code 1	2.00	0.75	4.00	1.50	6.00	2.50	3.50	1.25
Code 2	2.00	1.00	4.00	1.75	6.00	2.75	3.50	1.50
Code 3	2.00	1.25	4.00	2.00	6.00	3.00	3.50	1.75
Code 4	2.00	0.75	4.00	1.50	6.00	2.50	3.50	1.25
Code 5	2.00	1.00	4.00	1.75	6.00	2.75	3.50	1.50
Code 6	2.00	1.00	4.00	1.75	6.00	2.75	3.50	1.50
Code 7	2.00	1.00	4.00	1.75	6.00	2.75	3.50	1.50

Flow Meter #1 Price/oz Price Level C 0.50
 Flow Meter #2 Price/oz Price Level C 0.45
 Flow Meter #3 Price/oz Price Level C 1.50

PLU Report

If you have entered PLUs at the ECU for communication with a cash register, the PLU report lists the PLU assigned to each price code at every portion size and price level.

Available in Option Package(s): 744-Basic 744-CR AR FM ID DX

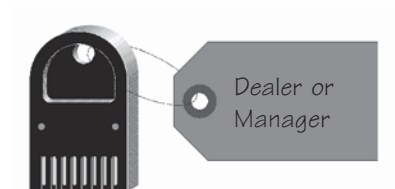

■ To generate a PLU report

1. Access the Manager Menu. (Insert your key, press ENTER, select the Manager Menu option and press ENTER.)

```
Use↑↓ and ENTER ↵
Manager Menu
```

```
Use↑↓ and ENTER ↵
View Reports
```

2. Use the up and down arrow keys to display the **View Reports** option and press ENTER.

```
Use↑↓ and ENTER ↵
PLU
```

3. Use the up and down arrow keys to select the **PLU** option and press ENTER.

```
Creating Report,
Please Wait
```

4. Wait for the report to be generated.

```
←=Exit      →=Print
Use↑ and↓ to view
```

5. If you have option package **CR**, view the report from the display using the up and down arrow keys. Press ENTER to quit viewing.

If you have option package **AR**, **FM**, **ID** or **DX**, use the right arrow key to print the report. The PLU report is a printer only report.

```
PLU Report
Printer-Only Report
```

6. Use the left arrow key to exit the report.

Note

- It's a good idea to keep a copy of the current PLU report in a safe place.

Berg All-Bottle 744 PLU Report

Station 1

Date: 01/31/97

Time: 08:23:46 PM

Price Level A

	Small	Regular	Large	Special
Code	PLU	PLU	PLU	PLU
Code 1	1	2	3	4
Code 2	5	6	7	8
Code 3	9	10	11	12
Code 4	13	14	15	16
Code 5	17	18	19	20
Code 6	21	22	23	24
Code 7	25	26	27	28

Price Level B

	Small	Regular	Large	Special
Code	PLU	PLU	PLU	PLU
Code 1	29	30	31	32
Code 2	33	34	35	36
Code 3	37	38	39	40
Code 4	41	42	43	44
Code 5	45	46	47	48
Code 6	49	50	51	52
Code 7	53	54	55	56

Price Level C

	Small	Regular	Large	Special
Code	PLU	PLU	PLU	PLU
Code 1	57	58	59	60
Code 2	61	62	63	64
Code 3	65	66	67	68
Code 4	69	70	71	72
Code 5	73	74	75	76
Code 6	77	78	79	80
Code 7	81	82	83	84

Price Level D

	Small	Regular	Large	Special
Code	PLU	PLU	PLU	PLU
Code 1	85	86	87	88
Code 2	89	90	91	92
Code 3	93	94	95	96
Code 4	97	98	99	100
Code 5	101	102	103	104
Code 6	105	106	107	108
Code 7	109	110	111	112

All Server Summary Reports (X and Z)

If you have option package **ID**, an all server summary Z or X report provides the total All-Bottle pours and sales for each server at each price level. If you have option package **DX**, the all-server report also shows the total flow meter volume and sales and total combined sales for each server at all four price levels. The all-server summary Z report zeros out all server sales data, but leaves all other sales data intact.

Available in Option Package(s): 744-Basic 744-CR AR FM ID DX

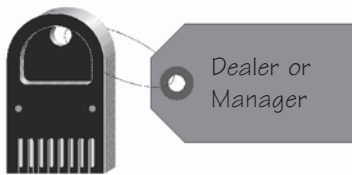

■ To generate an all server summary Z or X report

1. Access the Manager Menu. (Insert your key, press ENTER, select the Manager Menu option and press ENTER.)

```
Use↑ and ENTER ↵
Manager Menu
```

```
Use↑ and ENTER ↵
View Reports
```

2. Use the up and down arrow keys to display the **View Reports** option and press ENTER.

```
Use↑ and ENTER ↵
All Server Summary X
```

3. Use the up and down arrow keys to select the **All Server Summary Z** option or the **All Server Summary X** option and press ENTER.

```
Creating Report,
Please Wait
```

4. Wait for the report to be generated.

```
←=Exit      →=Print
Use↑ and↓ to view
```

5. Use the right arrow key to print the report or the left arrow key to exit the report. All server reports are printer only reports.

```
All Server Summary X
Printer-Only Report
```

Note

- The all server summary reports provide sales information for all servers in the current key assignment list.
- The Z number is the number of summary Z reports that have been run for that server. You can detect any unauthorized use of Z reports if you know what this number should be. (This Z number is separate from the ECU's Z number.)

Berg All-Bottle 744 All Server Summary Z Report

Station 1 Date: 02/21/97 Time: 07:00:29 PM

Servers	Z Number		
Alice	3		
Mike	3	Ron	3
Julie	3		

Price Level/ Server Name	All-Bottle Portions	All-Bottle Sales	Flow Meter oz	Flow Meter Sales	Total Sales
Price Level A					
Alice	33	87.00	96.13	74.00	161.00
Mike	18	25.75	169.00	51.00	76.75
Price Level B					
Alice	27	74.75	158.03	101.00	175.75
Mike	17	45.38	144.07	42.50	87.88
Price Level C					
Ron	35	90.00	0.00	0.00	90.00
Julie	29	73.50	0.00	0.00	73.50
Price Level D					
No Activity					
Report Totals	159	396.38	567.23	268.50	664.88

Individual Server Summary Reports (X and Z)

If you have option package **ID**, an individual server summary Z or X report provides the total All-Bottle pours and sales for a selected server at each price level. If you have option package **DX**, the server report also shows the total flow meter volume and sales and total combined sales for that server at all four price levels. The individual server summary Z report zeros out all sales data for that server, but leaves all other sales data intact. You can only generate an individual server summary Z report in the Manager Menu. You can generate a summary X report in either the Manager or Server Menu. To generate a report using the Server Menu see *Individual Server Reports Using the Server Menu* in this section.

Available in Option Package(s): 744-Basic 744-CR AR FM ID DX

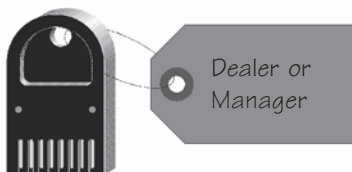

■ To generate an individual server summary Z or X report using the Manager menu:

1. Access the Manager Menu. (Insert your key, press ENTER, select the Manager Menu option and press ENTER.)

```
Use↑↓ and ENTER ↵
Manager Menu
```

```
Use↑↓ and ENTER ↵
View Reports
```

```
Use↑↓ and ENTER ↵
Summary Z by Server
```

```
Use↑↓ and ENTER ↵
04 Don
```

```
Creating Report,
Please Wait
```

```
←=Exit      →=Print
Use↑ and ↓  to view
```

2. Use the up and down arrow keys to display the **View Reports** option and press ENTER.
3. Use the up and down arrow keys to select the **Summary Z by Server** or the **Summary X by Server** option and press ENTER.
4. Use the up and down arrow keys to select the name of the individual server and press ENTER.
5. Wait for the report to be generated.
6. Use the right arrow key to print the report or the left arrow key to exit the report.

Use the up and down arrow keys to view the report. Press ENTER to quit viewing.

Note

- The Z number is the number of summary Z reports run for that server. You can detect any unauthorized use of Z reports if you know what this number should be. (This Z number is separate from the ECU's Z number.)

Berg All-Bottle 744 Summary Z by Server Report

Station 1 Date: 08/26/96 Time: 06:47:18 PM

Z Number 3

Server: MIKE

All-Bottle Sales

	Portions	Sales
Price Level A	18	25.75
Price Level B	17	145.38
Price Level C	13	15.75
Price Level D	17	21.25
Totals	65	208.13

Flow Meter Sales

	Volume (oz)	Sales
Price Level A	169.00	51.00
Price Level B	144.07	42.50
Price Level C	0.00	0.00
Price Level D	0.00	0.00
Totals	313.07	93.50

Total Sales MIKE 301.63

Individual Server Reports Using the Server Menu

If you have option package **ID**, individual servers can view their own summary X reports if you enable this feature. Summary X reports show the total number of pours and the total sales for each price level. If you have option package **DX**, the server report also shows the total flow meter volume and sales and total combined sales for that server at all four price levels.

Available in Option Package(s): 744-Basic 744-CR AR FM ID DX

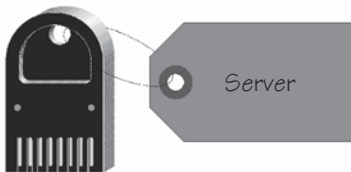

■ To generate an individual server summary X report using the Server Menu:

1. Access the Server Menu. (Insert your key, press ENTER, select the Server Menu option and press ENTER.)

```
Use↑ and ENTER ↓
Server Menu
```

```
Use↑ and ENTER ↓
Summary X by Server
```

2. Use the up and down arrow keys to select the **Summary X by Server** option and press ENTER.

```
Creating Report,
Please Wait
```

3. Wait for the report to be generated.

```
←=Exit      →=Print
Use↑ and↓ to view
```

4. Use the left arrow key to exit the report or the right arrow key to print the report.

Use the up and down arrow keys to view the report. Press ENTER to quit viewing.

Notes

- Individual servers can only access reports through the Server Menu if you have enabled this option in the Manager Menu. See *Enable Server Menu* in the *Pouring Control* section.
- The server key inserted to access the Server Menu must be listed in the current Key Assignment list to access reports.

Berg All-Bottle 744 Summary X by Server Report

Station 1 Date: 08/26/96 Time: 06:47:18 PM

Server: MIKE

All-Bottle Sales

	Portions	Sales
Price Level A	18	25.75
Price Level B	17	145.38
Price Level C	13	15.75
Price Level D	17	21.25
Totals	65	208.13

Flow Meter Sales

	Volume (oz)	Sales
Price Level A	169.00	51.00
Price Level B	144.07	42.50
Price Level C	0.00	0.00
Price Level D	0.00	0.00
Totals	313.07	93.50

Total Sales MIKE 301.63

Clear Cumulative Sales

The **All-Bottle 744** or **1544** ECU keeps a running total of all sales separate from the sales totals cleared in Z reports. The cumulative sales total appears on both the summary and detailed X and Z reports (but not server summary reports). To clear these cumulative sales, you must have a dealer or manager key and use a password (if you've defined a password).

Available in Option Package(s): 744-Basic 744-CR AR FM ID DX

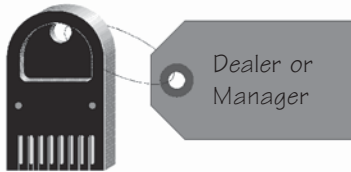

■ To clear cumulative sales

1. Insert your **Manager** access key in the ECU's key slot and press ENTER.

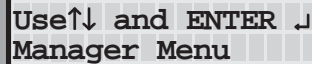

```
Use↑ and ENTER ↓
Manager Menu
```

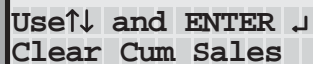

```
Use↑ and ENTER ↓
Clear Cum Sales
```

2. Use the up and down arrow keys to display the **Clear Cum Sales** option and press ENTER.

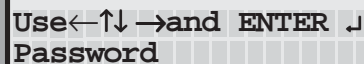

```
Use←↑↓→and ENTER ↓
Password _
```

3. Key in the password and press ENTER.

Use the left and right arrow keys to move the cursor through the five fields. Use the up and down arrow keys to select characters from the following list: ! " # \$ % & ' () * + , - . / 0-9 : ; < = > ? @ A-Z [(yen character)] ^ _ ` a-z { | } → and space in that order.

If you haven't defined a password, press ENTER.

If you successfully match the defined password, the display tells you when the sales are cleared.



```
Cum Sales Cleared
```

The display returns to the **Clear Cum Sales** option.

Notes

- The cumulative sales password is case sensitive, and is defined in the Dealer Menu. See *Cumulative Sales Password* in the *ECU Setup* section.
- You typically clear cumulative sales after running a Z report. If you clear cumulative sales with active sales data still in the ECU, your first Z report after clearing cumulative sales will show higher totals than the cumulative sales.

Berg All-Bottle 744 Summary X Report

Station 1 Date: 06/23/96 Time: 09:49:00 PM

All-Bottle Sales

	Portions	Sales
Price Level A	35	48.75
Price Level B	21	150.88
Price Level C	34	41.75
Price Level D	36	44.25
Totals	126	285.63

Report Total Sales 285.63

Cumulative Sales 0.00

|
Clearing cumulative sales
resets the running total to 0.

9 Maintenance and Upgrading

Proper cleaning and maintenance of the **All-Bottle 744** or **1544** system is essential. Refer to information in this section for the following tasks:

Clean the All-Bottle 744 or 1544 ECU	9-2
Clean the All-Bottle Coded Pourers	9-3
Replace the ECU Battery	9-4
Change the EPROM	9-6
Install an Option Board	9-8

Clean the ECU

Clean the ECU and activator ring about once a week. The ECU is designed to protect the electronics inside from moisture, but bartenders should still be cautioned to avoid splashing water or drinks on the ECU.

Available in Option Package(s): 744-Basic 744-CR AR FM ID DX

■ To clean the All-Bottle 744 or 1544 ECU:

1. Wipe the front of the ECU with a damp (not dripping) cloth or sponge.
2. Wipe the activator ring and activator ring holder with a damp (not dripping) cloth or sponge.

Note

- Do not attempt any more thorough cleaning of an ECU, and absolutely do not attempt to clean any internal circuit boards or surfaces.

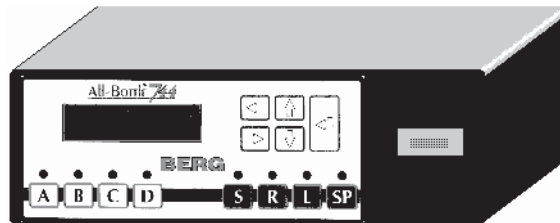

All-Bottle 744 ECU

Clean the Coded Pourers

The All-Bottle coded pourers are carefully designed for liquor dispensing applications. They impart no taste or odor to liquor and should only be cleaned with clear water. Each pourer should be cleaned every time it is removed from a bottle. Berg provides a pourer washing fixture for this purpose.

Available in Option Package(s): 744-Basic 744-CR AR FM ID DX

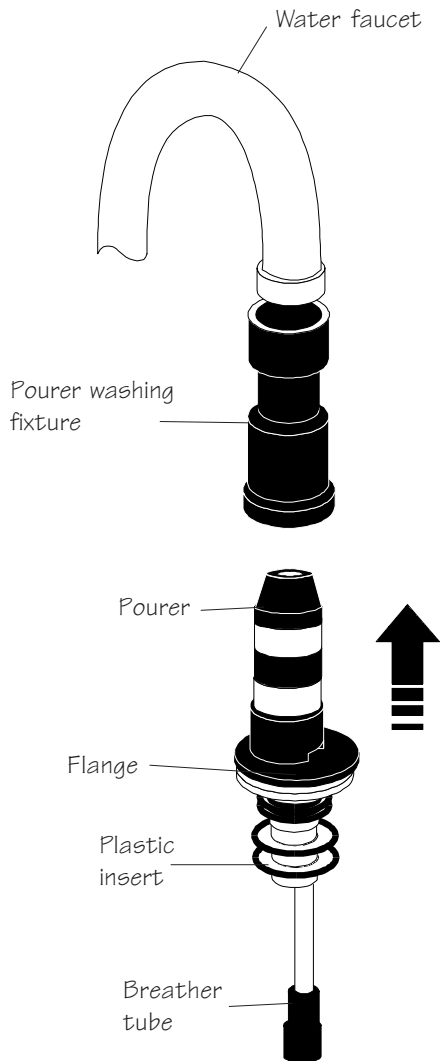

■ To clean an All-Bottle 744 or 1544 coded pourer:

1. Attach the smaller end of the pourer washing fixture (Berg PN 9007191) to your faucet. Turn on a gentle flow of warm water.
2. Insert a coded pourer into the pourer washing fixture with the tip of the pourer pointed slightly away from you.
3. Snap the flange of the coded pourer into the washing fixture and hold it there for a few seconds.

Two streams of water (one from the end of the breather tube and the other from inside the plastic insert) flow from the coded pourer when all passages are clear. Especially gummy pourers may need to be held in the washing fixture a little longer until both streams of water are running freely.

Notes

- Never clean your pourers in a dishwasher.
- Never use soap to clean a pourer. Unless removed completely, soap can get into your liquor. It can also react chemically with the specially formulated plastics and make them brittle, shortening the useful life of your pourers.
- If a pourer is removed from a bottle and allowed to dry without being cleaned, soak it for several minutes in clear, warm water to loosen the dried liquor before inserting the pourer in the washing fixture. Repeat the soaking and rinsing if necessary.
- Check the plastic insert of a pourer when cleaning. Liquor drying on the plastic may remove some of the plastic's elasticity. If the plastic insert remains stiff after cleaning, replace it.

Replace the ECU Battery

If AC power to the ECU is constantly maintained, the lithium battery inside the ECU should provide years of service. The symptoms of a dying battery may include loss of setup data or sales records when the ECU is unplugged.

Available in Option Package(s): 744-Basic 744-CR AR FM ID DX

■ To replace the battery in a 744 or 1544 ECU:

1. Run a Z report on the system to save the latest sales information. If you do not already have copies, run a configuration report to save all the setup and calibration data, a price/portion report and a PLU report.
2. Unplug the ECU and disconnect all cables to the back of the ECU.
3. Loosen the two screws on each side of the ECU with a hex wrench. Loosen the stand off nuts on the back of the ECU with a nut driver. Open the bottom of the ECU.
4. Remove the old battery by inserting the tip of a small screwdriver under it and gently prying it from its socket.
5. Insert the new battery into the battery socket, being sure to align the positive “+” side of the battery with the positive “+” side of the socket. When fully inserted, the battery will be level with the ends of the socket.
6. Replace the bottom of the ECU by tightening the four screws that secure it on the sides and the two stand off nuts on the back.
7. Plug in the ECU.
8. Using the configuration, price/portion and PLU reports, reenter the setup, calibration and portion size data for the system.

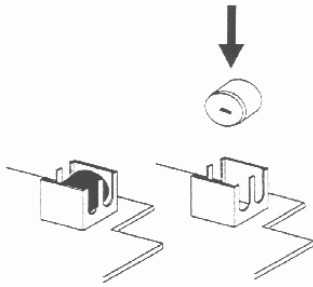

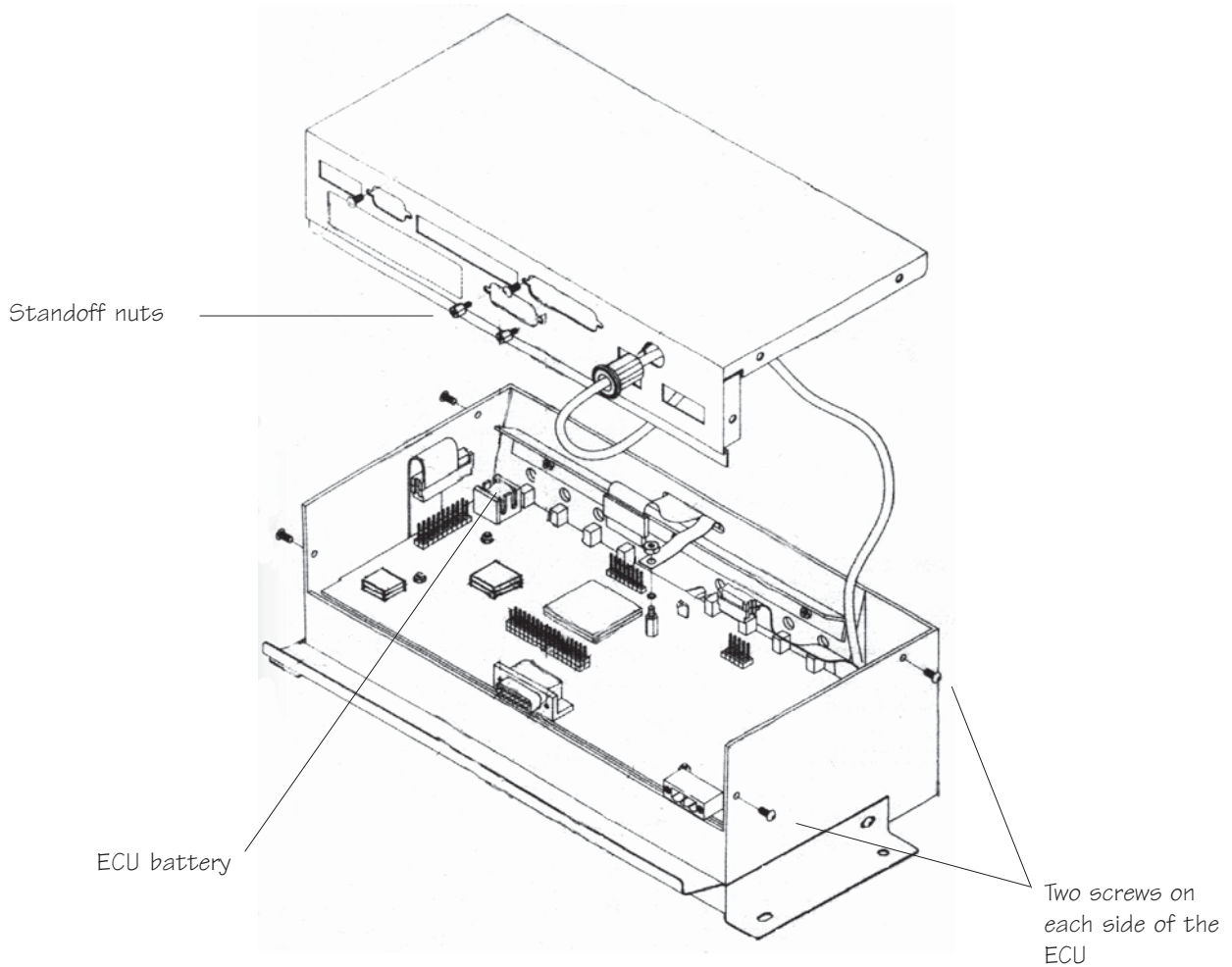

Warning:



Lithium is poisonous if swallowed. Be careful not to puncture the battery case when removing an old battery or inserting a new one. Lithium batteries are not rechargeable and should be properly disposed of upon removal. Replace an old battery with Berg PN 8007776, a Duracell type DL1/3N, or an equivalent replacement battery.

Caution:



Electronic components are sensitive to static electricity. If possible, avoid working on the **744** or **1544** ECU while standing on a carpeted surface. Before you open the ECU, discharge any static electricity from your body by touching any known grounded metal surface. Also discharge the static repeatedly in like manner while working on the ECU.

Change the EPROM

If you upgrade your **All-Bottle 744** or **1544** system, you need to replace the EPROM chip in the ECU. Replacing the chip is not difficult—it just requires a certain amount of care to protect the fragile pins on the sides of the chip.

Available in Option Package(s): **744-Basic** **744-CR** **AR** **FM** **ID** **DX**

■ To change the EPROM in a 744 or 1544 ECU:

1. Run a Z report on the system to save the latest sales information. If you do not already have copies, run a configuration report to save all the setup and calibration data, a price/portion report and a PLU report. This is necessary because changing EPROMs clears all setup and sales data in the ECU.
2. Unplug the ECU and disconnect all cables to the back of the ECU.
3. Loosen the two screws on each side of the ECU with a hex wrench. Loosen the stand off nuts on the back of the ECU with a nut driver. Open the bottom of the ECU.
4. Remove the old EPROM with the PROM remover tool (Berg PN 8004798). Follow the instructions accompanying the tool. Note the orientation of the chip.
5. Insert the new EPROM into the socket by aligning the angled corner of the chip with the angled corner of the socket. (It should match the orientation of the old chip.)

Be sure all EPROM pins are aligned with the socket. Take care not to bend or damage any of the pins. Gently press straight down on the EPROM until it locks into position.

6. Replace the bottom of the ECU by tightening the four screws that secure it on the sides and the two stand off nuts on the back.
7. Plug in the ECU.
8. Using the configuration, price/portion and PLU reports, reenter the setup, calibration and portion size data for the system.

Note

- If you have **All-Bottle Manager**, save a file with current setup data before changing the EPROM. You can then use this file to easily restore the data to the ECU.

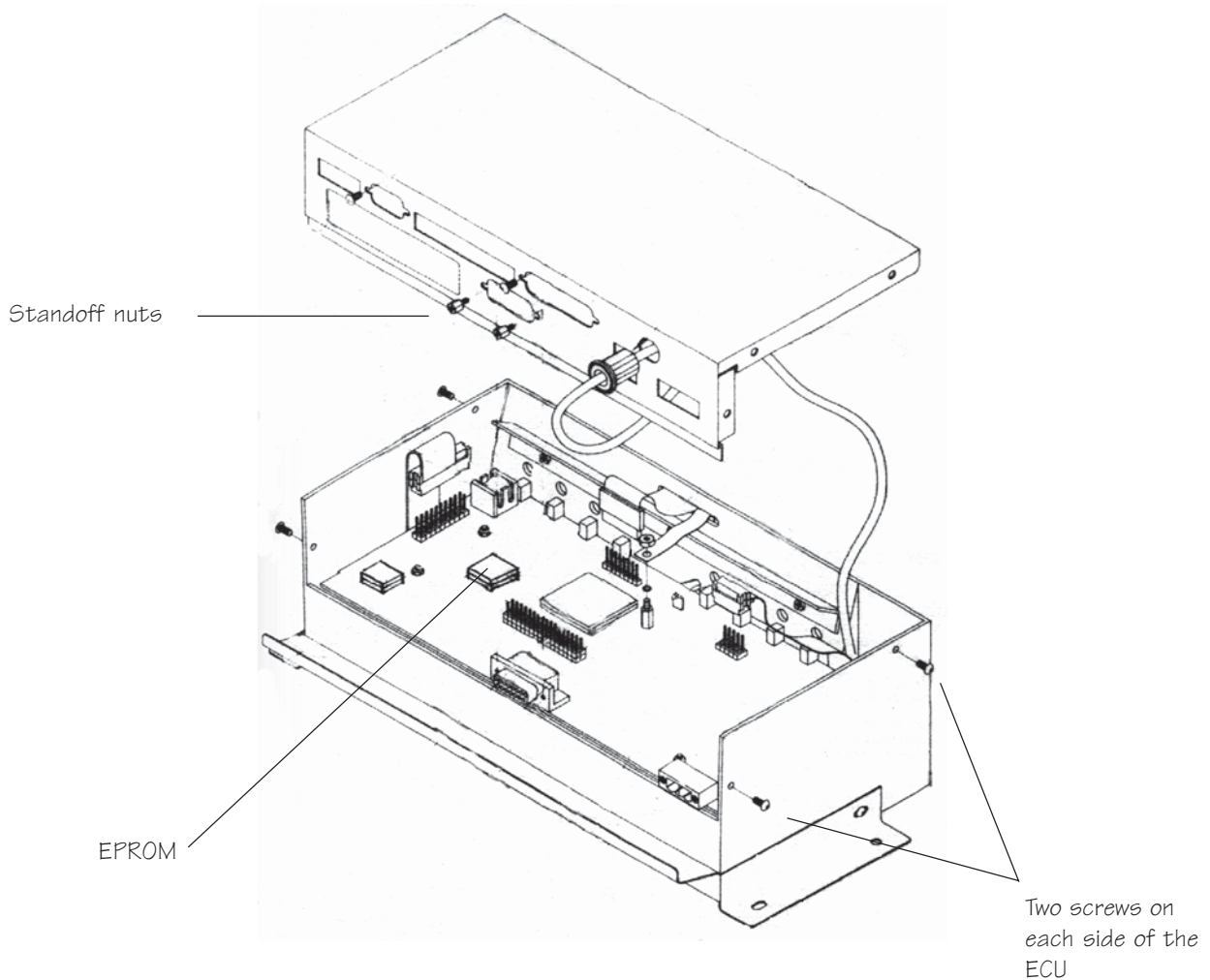

Caution:



Electronic components are sensitive to static electricity. To prevent damage, the **All-Bottle 744** or **1544** option card and EPROM are shipped in protective anti-static packaging. Before removing these components from their protective packaging discharge any static electricity from your body by touching any known grounded metal surface. Also, if possible, avoid working on the **744** or **1544** ECU while standing on a carpeted surface. Similarly, before you open the ECU, discharge any static electricity from your body by touching any known grounded metal surface. Discharge the static repeatedly in like manner while working on the ECU.

Install an Option Board

If you upgrade your **All-Bottle 744** or **1544** system, you need to install an option board in the ECU for option packages **AR**, **FM**, **ID** or **DX**. The option board provides the ports to connect a printer, remote server access box and flow meters.

Available in Option Package(s): **744-Basic** **744-CR** **AR** **FM** **ID** **DX**

■ To install an option board in a 744 or 1544 ECU:

1. Run a Z report on the system to save the latest sales information. If you do not already have copies, run a configuration report to save all the setup and calibration data, a price/portion report and a PLU report. This is necessary because installing an option board clears all setup and sales data in the ECU.
2. Unplug the ECU and disconnect all cables to the back of the ECU.
3. Loosen the two screws on each side of the ECU with a hex wrench. Loosen the stand off nuts on the back of the ECU with a nut driver. Open the bottom of the ECU.
4. Locate the 34-pin header on the ECU system board.
5. Match the 34-pin connector on the bottom of the option board with the 34-pin header on the system board. (Two standoff screws protrude through two holes in the option board when it is aligned correctly.)
6. Press down gently to lock the option board into position. The ports attached to the option board should be facing the back of the ECU.
7. Secure the option board. Use a washer and nut on each standoff screw and tighten with a nut driver.
6. Replace the cover on the ECU. Tighten the two screws on each side of the ECU with a hex wrench. Tighten the hold down nuts that secure the option board to the back of the ECU with a nut driver.
7. Plug in the ECU.
8. Using the configuration, price/portion and PLU reports, reenter the setup, calibration and portion size data for the system.

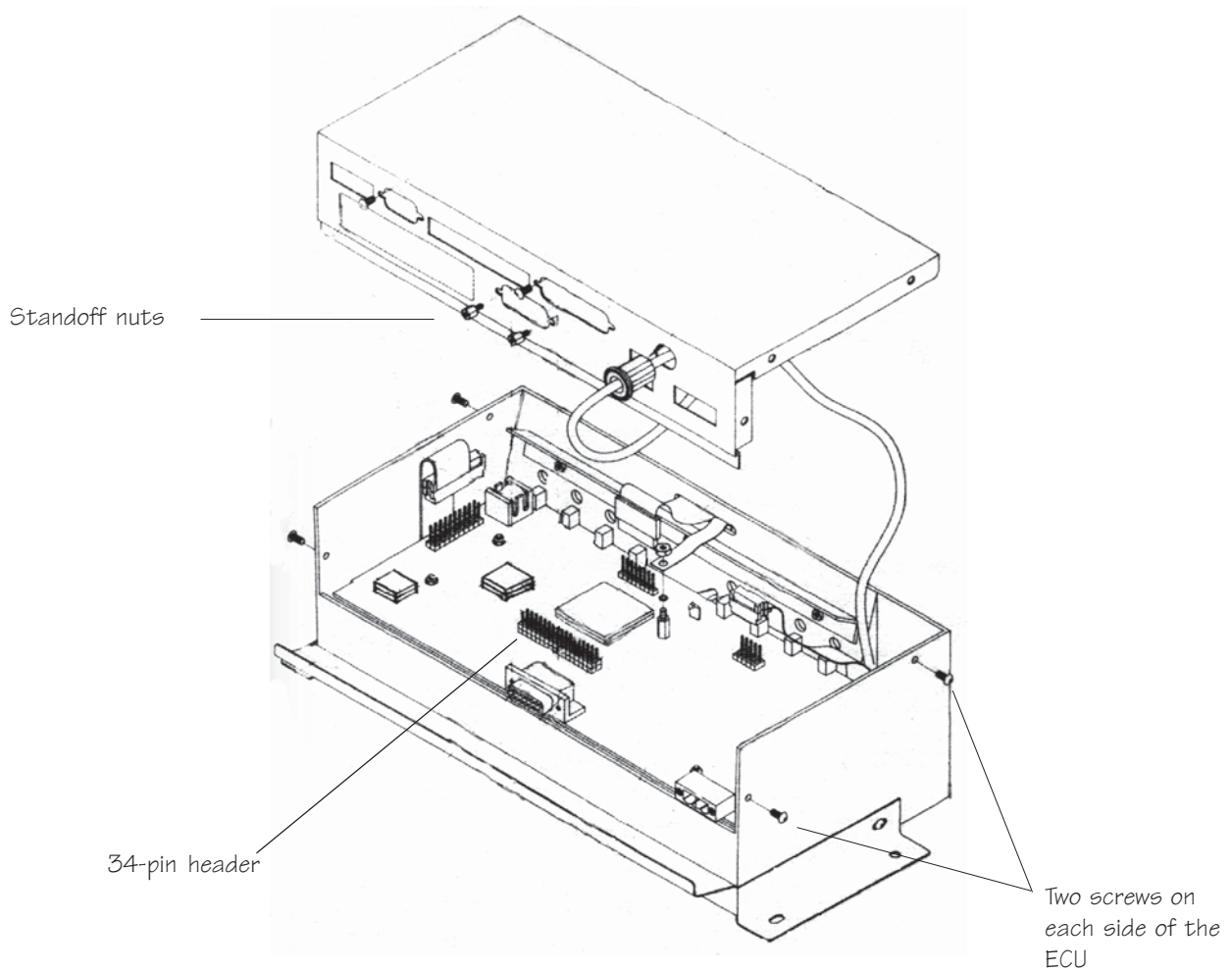

Caution:



Electronic components are sensitive to static electricity. To prevent damage, the **All-Bottle 744** or **1544** option card and EPROM are shipped in protective anti-static packaging. Before removing these components from their protective packaging discharge any static electricity from your body by touching any known grounded metal surface. Also, if possible, avoid working on the **744** or **1544** ECU while standing on a carpeted surface. Similarly, before you open the ECU, discharge any static electricity from your body by touching any known grounded metal surface. Discharge the static repeatedly in like manner while working on the ECU.

SECTION 10 All-Bottle Manager Software

The **All-Bottle Manager** software is a convenient alternative to data entry at the ECU. It does not offer any additional liquor control features; it simply provides a computer format for entering portion, price and PLU data and for generating reports. To use the software, be sure you've installed a connection from the ECU to your computer. See *Interface the ECU to a Serial Printer or Computer* in the *Hardware Installation* section. See the online help accompanying the software or use this section for help with the following tasks:

Install the Software	10-2
Communication Settings	10-4
Price and Volume Units	10-5
Select an ECU Type	10-6
Transfer Data between the ECU and the Computer	10-8
Define Prices and Portion Sizes	10-10
Define PLUs	10-12
Set Flow Meter Counts and Price per Unit	10-14
Print Setup Data	10-16
Key Assignment List	10-18
Generate Reports	10-20
Perform a Loopback Test	10-22
Perform a Communication Test	10-23
Check Option Package	10-24
Diagnostic Mode	10-25
All-Bottle Manager Files	10-26

Install the Software

The **All-Bottle Manager** software comes with its own install program. Simply respond to its prompts for an easy software installation.

Available in Option Package(s): 744-Basic 744-CR AR FM ID DX



■ To install the All-Bottle Manager software:

1. Launch Windows.
2. Insert the **All-Bottle Manager** disk into drive A.
3. Select **File** from the Program Manager menu bar (Windows 3.1), or select **Start** (Windows 95).
4. Select **Run** from the menu.
5. Type **a:\setup** and press Enter.
6. When prompted, enter the dealer's name and phone number for technical support and click **Next**. (The default technical support is Berg Company.)
7. When prompted, click **Next** to accept the default destination directory (C:\BergAB\) for the software. If you prefer a different destination, enter a new directory.
8. When the installation is complete, double-click on the **All-Bottle Manager** icon in the Berg All-Bottle program group (Windows 3.1) or click on the **All-Bottle Manager** icon in the Berg All-Bottle folder (Windows 95) to use the software.



Notes

- To communicate with the **All-Bottle 744** or **1544** ECU, your computer must be linked to the ECU using the converter assembly that comes with the software. See *Interface the 744 or 1544 to a Printer or Computer* in the *Hardware Installation* section.
- To communicate with more than one ECU, see *Install a Switch Box with a Serial Printer or Computer Interface* in the *Hardware Installation* section.

Enter the dealer's name and phone number for technical support.

Technical Support Info

Please enter the dealer's name and phone number. This information will appear in the About box for customer reference in case of questions about this product. If you do not enter a name and number, Berg's name and phone number will be entered by default.

Dealer: Joe Dealer

Phone: (123) 456-7890

< Back Next > Cancel

Menu bar



Communication Settings

The communication settings in your ECU and computer must match for data to be transferred.

Available in Option Package(s): 744-Basic 744-CR AR FM ID DX

■ To change communication settings:

1. Select **Setup** from the **All-Bottle Manager** menu bar.
2. Select **Communications...** from the **Setup** menu.
3. Select the COM port your computer uses to communicate with the ECU.
4. Select the baud rate used for communication. This rate must match the baud rate entered at the ECU.
5. Click **OK** to save your selections. The software stores your selections, so you don't have to reset them each time you start the program.

Note

- The default baud rate in the ECU is 19200. Generally speaking, you should use the fastest rate at which you can successfully communicate with the ECU.

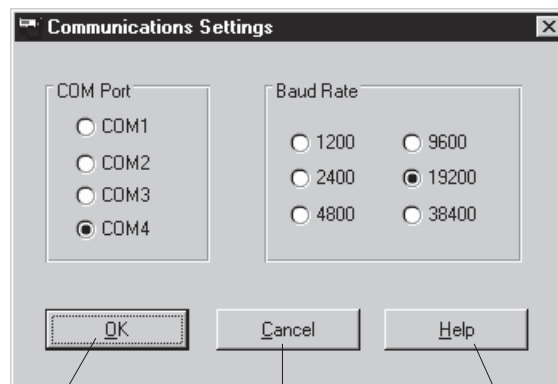

Click **OK** to save your choice and return to the main menu.

Click **Cancel** to return to the main menu without saving any changes.

Click **Help** if you have questions.

Price and Volume Units

The price and volume unit settings in your ECU and computer must match for price and portion setup data to be transferred. If the price and volume units do not match at the time you run a report with the software, the data is sent in the format set at the ECU.

Available in Option Package(s): 744-Basic 744-CR AR FM ID DX

■ To change price and volume unit settings:

1. Select **Setup** from the **All-Bottle Manager** menu bar.
2. Select **Price & Volume Units...** from the **Setup** menu.
3. Select the price format used at the ECU to record sales.
4. Select the volume units used at the ECU to measure portions.
5. Click **OK** to save your selections. The software stores your selections, so you don't have to reset them each time you start the program.

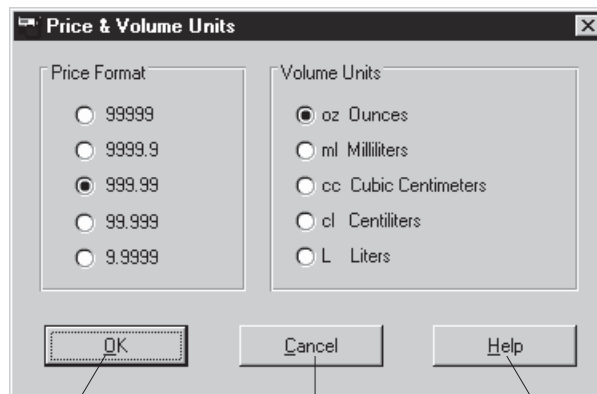

Click **OK** to save your choice and return to the main menu.

Click **Cancel** to return to the main menu without saving any changes.

Click **Help** if you have questions.

Select an ECU Type

You must specify which type of ECU you have (**744** or **1544**) for the software to correctly access and transfer data to the ECU.

Available in Option Package(s): 744-Basic 744-CR AR FM ID DX

■ To select an ECU type:

1. Select **Setup** from the **All-Bottle Manager** menu bar.
2. Select **Select ECU type...** from the **Setup** menu.
3. Select the ECU type.
4. Click **OK** to save your selection. The software stores your selection, so you don't have to reset it each time you start the program.

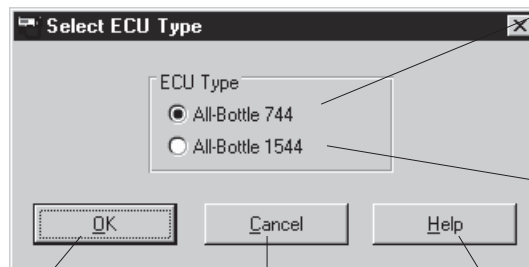

Click **OK** to save your choice and return to the main menu.

Click **Cancel** to return to the main menu without saving any changes.

Click **Help** if you have questions.

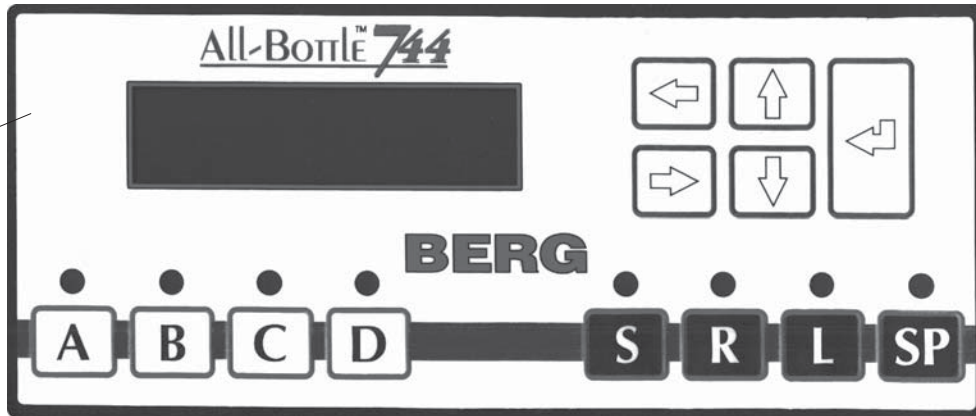

Transfer Data between the ECU and the Computer

An important part of entering portion, price and other data with **All-Bottle Manager** software is getting that information from the computer into the ECU (and back to the computer again if you want to edit your choices). Transferring data is easy, but it's important to understand which data you're working with at all times.

Available in Option Package(s): **744-Basic** **744-CR** **AR** **FM** **ID** **DX**

If you already have price/portion/PLU data entered at the ECU and you want to edit the data at the computer, perform these steps to transfer the data.

■ To transfer data from the ECU to the computer:

1. Select **Setup** from the **All-Bottle Manager** menu bar.
2. Select **Prices/Portions/PLUs...** from the **Setup** menu.

The **Price/Portion/PLU Setup** screen is displayed with the **Prices & Portions** tab selected.

3. Click **Read ECU**.

Data for all three tabs of the Setup screen (**Prices & Portions, PLUs, Flow Meters**) is transferred from the ECU to the computer at the same time.

4. Perform the necessary steps to enter or edit the correct data in all three tabs (**Prices & Portions, PLUs, Flow Meters**). See *Define Portion Sizes and Prices*, *Define PLUs* and *Set Flow Meter Counts and Price per Unit* in this section.

Notes

- Communication settings, price format and volume units at the ECU and computer must match. See *Communication Settings* and *Price and Volume Units* in this section.
- You cannot perform other operations while the data is being transferred.
- If you encounter difficulty communicating with the ECU, see the *Troubleshooting* section.

If you are entering initial setup data at the computer and you want to send it to the ECU or you've edited data from the ECU and now you want to send it back, perform these steps to transfer the data.

■ **To transfer data from the computer to the ECU:**

1. Select **Setup** from the **All-Bottle Manager** menu bar.
2. Select **Prices/Portions/PLUs...** from the **Setup** menu.

The **Price/Portion/PLU Setup** screen is displayed with the **Prices & Portions** tab selected.

3. Perform the necessary steps to enter or edit the correct data in all three tabs (**Prices & Portions**, **PLUs**, **Flow Meters**). See *Define Portion Sizes and Prices*, *Define PLUs* and *Set Flow Meter Counts and Price per Unit* in this section.
4. When you have completed editing for all three tabs, click **Load ECU**.

Data for all three tabs (**Prices & Portions**, **PLUs**, **Flow Meters**) of the current **Setup** screen is transferred from the computer to the ECU at the same time.

This transfer of data to the ECU overwrites any data previously entered at the ECU or previously sent to the ECU from the computer.

Lower portion of Price/Portion/PLU Screen

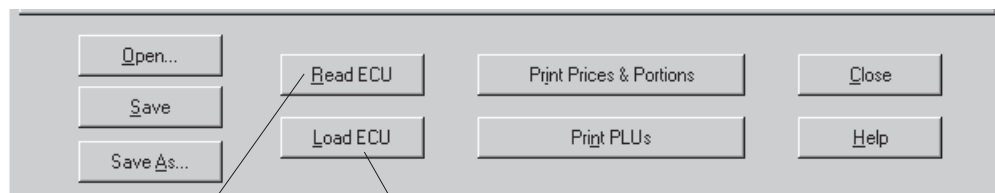

Transfers data for all three tabs from the ECU to the computer.

Transfers data for all three tabs from the computer to the ECU.

Define Portion Sizes and Prices

You can enter all portion sizes and prices using one form in the **All-Bottle Manager** software. You can then save your entries to a file, print them out and/or download them to the **All-Bottle 744** or **1544** ECU.

Available in Option Package(s): 744-Basic 744-CR AR FM ID DX

■ To define portion sizes and prices:

1. Select **Setup** from the **All-Bottle Manager** menu bar.
2. Select **Prices/Portions/PLUs...** from the **Setup** menu.

The **Price/Portion/PLU Setup** screen is displayed with the **Prices & Portions** tab selected.

3. To enter portions and prices for the first time: proceed with step 4.

To edit portions and prices from the ECU: see *Transferring Data between the ECU and Computer* in this section. Then proceed with step 4.

To edit a file you've previously saved at the computer: click **Open** and enter the name of the file you want to edit. This file contains data for all three tabs (**Prices & Portions**, **PLUs**, **Flow Meters**) of the **Setup** screen. Proceed with step 4.

4. Select the correct row and column in the table using arrow keys, the Tab key, the Enter key or a mouse.
5. Enter the correct portion sizes and/or prices. If your entry is a whole number, you don't need to enter a decimal point.
6. When you've completed your entries, enter or edit the correct data (if any) in the other tabs (**PLUs**, **Flow Meters**). See *Define PLUs* and *Set Flow Meter Counts and Price per Unit* in this section.
7. To save your entries in the computer file you've opened: click **Save**. Data in all three tabs is saved at the same time.

To save your entries in a new computer file: click **Save As...**, enter the name you want to give the file and click **OK**. Data in all three tabs is saved at the same time.

8. To download prices and portions to the ECU: see *Transfer Data between the ECU and Computer* in this section.
9. To print the price and portion entries you've made: see *Print Setup Data* in this section.

The four price levels and seven or fifteen price codes are denoted by A1-7 (or 1-15), B1-7 (or 1-15), C1-7 (or 1-15), etc.

The Prices & Portions tab

Click Close to return to the main menu.

Use the arrow keys, the Tab key, the Enter key or a mouse to move between rows and columns.

If your entry is a whole number, you don't need to enter a decimal point. If you make a mistake, use the Delete key to erase any amount currently highlighted.

If you have All-Bottle 744 Basic or CR, just enter portion sizes.

Click Open to view a previously saved file. The file contains data for all three tabs.

Click Save to replace previous data in the file with the new data. If you have PLU or flow meter data in the file it will also be saved.

Level and Code	Small Portion (oz)	Small Price	Regular Portion (oz)	Regular Price	Large Portion (oz)	Large Price	Special Portion (oz)	Special Price
A - 1	0.00	0.00	0.00	0.00	0.00	0.00	0.00	0.00
A - 2	0.00	0.00	0.00	0.00	0.00	0.00	0.00	0.00
A - 3	0.00	0.00	0.00	0.00	0.00	0.00	0.00	0.00
A - 4	0.00	0.00	0.00	0.00	0.00	0.00	0.00	0.00
A - 5	0.00	0.00	0.00	0.00	0.00	0.00	0.00	0.00
A - 6	0.00	0.00	0.00	0.00	0.00	0.00	0.00	0.00
A - 7	0.00	0.00	0.00	0.00	0.00	0.00	0.00	0.00
B - 1	0.00	0.00	0.00	0.00	0.00	0.00	0.00	0.00
B - 2	0.00	0.00	0.00	0.00	0.00	0.00	0.00	0.00
B - 3	0.00	0.00	0.00	0.00	0.00	0.00	0.00	0.00
B - 4	0.00	0.00	0.00	0.00	0.00	0.00	0.00	0.00
B - 5	0.00	0.00	0.00	0.00	0.00	0.00	0.00	0.00
B - 6	0.00	0.00	0.00	0.00	0.00	0.00	0.00	0.00
B - 7	0.00	0.00	0.00	0.00	0.00	0.00	0.00	0.00

Click Save As... to save the file under a new name.

Click Print Prices & Portions for a report listing all prices and portions.

Click Help if you have questions.

Click Read or Load the ECU to transfer data for all three setup tables (portion/price, PLU, flow meter) at the same time. Price format and volume units at the ECU and computer must match. You cannot perform other operations while the data is being transferred.

Define PLUs

You can quickly enter PLUs (for the **All-Bottle 744** or **1544** ECU to communicate with a cash register) using the **All-Bottle Manager** software.

Available in Option Package(s): 744-Basic 744-CR AR FM ID DX

■ To define PLUs:

1. Select **Setup** from the **All-Bottle Manager** menu bar.
2. Select **Prices/Portions/PLUs...** from the **Setup** menu.

The **Price/Portion/PLU Setup** screen is displayed with the **Prices & Portions** tab selected.

3. Select the **PLUs** tab.
4. To enter PLUs for the first time: proceed with step 5.

To edit PLUs from the ECU: see *Transfer Data between the ECU and Computer* in this section. If you already transferred the data proceed with step 5.

To edit a file you've previously saved at the computer: click **Open** and enter the name of the file you want to edit. This file contains data for all three tabs (**Prices & Portions**, **PLUs**, **Flow Meters**) of the **Setup** screen. If you already opened a file, proceed with step 5.

5. Select the correct row and column in the table using arrow keys, the Tab key, the Enter key or a mouse.
6. Enter the PLUs.
7. When you've completed your entries, enter or edit the correct data (if any) in the other tabs (**Prices & Portions**, **Flow Meters**). See *Define Portion Sizes and Prices* and *Set Flow Meter Counts and Price per Unit* in this section.

8. To save your entries in the computer file you've opened: click **Save**. Data is saved for all three tabs.

To save your entries in a new computer file: click **Save As...**, enter the name you want to give the file and click **OK**. Data is saved for all three tabs.

9. To download PLUs to the ECU: see *Transfer Data between the ECU and Computer* in this section.
10. To print the PLU entries you've made: see *Print Setup Data* in this section.

The four price levels and seven or fifteen price codes are denoted by A1-7 (or 1-15), B1-7 (or 1-15), C1-7 (or 1-15), etc.

The PLUs tab

Click Close to return to the main menu.

Use the arrow keys, the Tab key, the Enter key or a mouse to move between rows and columns. You can enter PLUs up to four digits long. If you make a mistake, use the Delete key to erase any amount currently highlighted.

Click Open to view a previously saved file. The file contains data for all three tabs.

Click Save to replace previous data in the file with the new data. If you have PLU or flow meter data in the file it will also be saved.

Click Save As... to save the file under a new name.

Click Print PLUs for a report listing PLU setup data.

Click Help if you have questions.

Click Read or Load the ECU to transfer data for all three setup tables (portion/price, PLU, flow meter) at the same time. Price format and volume units at the ECU and computer must match. You cannot perform other operations while the data is being transferred.

The screenshot shows a window titled "Price/Portion/PLU Setup - D:\BERG744\Default.ppn". It has three tabs: "Prices & Portions", "PLUs", and "Flow Meters". The "PLUs" tab is active, displaying a table with the following data:

Level and Code	Small PLU	Regular PLU	Large PLU	Special PLU
A - 1	2	3	4	
A - 2	5	6	7	8
A - 3	9	10	11	12
A - 4	13	14	15	16
A - 5	17	18	19	20
A - 6	21	22	23	24
A - 7	25	26	27	28
B - 1	29	30	31	32
B - 2	33	34	35	36
B - 3	37	38	39	40
B - 4	41	42	43	44
B - 5	45	46	47	48
B - 6	49	50	51	52
B - 7	53	54	55	56

At the bottom of the window are several buttons: "Open...", "Save", "Save As...", "Read ECU", "Load ECU", "Print Prices & Portions", "Print PLUs", "Close", and "Help".

Set Flow Meter Counts and Price per Unit

If you have flow meters, the **All-Bottle Manager** software provides one table for entering all flow meter data.

Available in Option Package(s): 744-Basic 744-CR AR FM ID DX

■ To set flow meter counts and price per unit:

1. Select **Setup** from the **All-Bottle Manager** menu bar.
2. Select **Prices/Portions/PLUs...** from the **Setup** menu.

The **Price/Portion/PLU Setup** screen is displayed with the **Prices & Portions** tab selected.

3. Select the **Flow Meters** tab.
4. To enter data for the first time: proceed with step 5.

To edit flow meter data from the ECU: see *Transferring Data between the ECU and Computer* in this section. If you already transferred the data proceed with step 5.

To edit a file you've previously saved at the computer: click **Open** and enter the name of the file you want to edit. This file contains data for all three tabs (**Prices & Portions, PLUs, Flow Meters**) of the **Setup** screen. If you already opened a file, proceed with step 5.

5. Select the correct row and column in the table using arrow keys, the Tab key, the Enter key or a mouse.
6. Enter the correct flow meter data.
7. When you've completed your entries, enter or edit the correct data (if any) in the other tabs (**Prices & Portions, PLUs**). See *Define Portion Sizes and Prices* and *Define PLUs* in this section.

8. To save your entries in the computer file you've opened: click **Save**. Data is saved for all three tabs.

To save your entries in a new computer file: click **Save As...**, enter the name you want to give the file and click **OK**. Data is saved for all three tabs.

9. To download flow meter data to the ECU: see *Transfer Data between the ECU and Computer* in this section.
10. To print the flow meter entries you've made: see *Print Setup Data* in this section.

The four price levels are denoted by A, B, C, D.

The Flow Meters tab

Click Close to return to the main menu.

Use the arrow keys, the Tab key, the Enter key or a mouse to move between rows and columns. If you make a mistake, use the Delete key to erase any amount currently highlighted.

The screenshot shows a window titled "Price/Portion/PLU Setup - D:\BERG744\Default.ppn". It has three tabs: "Prices & Portions", "PLUs", and "Flow Meters". The "Flow Meters" tab is active, displaying a table titled "Flow meter price/oz". The table has six columns: "Flow Meter", "Level A", "Level B", "Level C", "Level D", and "Meter Count". There are three rows of data. Below the table is a control panel with buttons for "Open...", "Save", "Save As...", "Read ECU", "Load ECU", "Print Prices & Portions", "Print PLUs", "Close", and "Help".

Flow Meter	Level A	Level B	Level C	Level D	Meter Count
1	0.30	0.40	0.50	0.25	689
2	0.25	0.35	0.45	0.20	697
3	1.00	1.25	1.50	0.75	705

Click Open to view a previously saved file. The file contains data for all three tabs.

Click Save to replace previous data in the file with the new data. If you have PLU or flow meter data in the file it will also be saved.

Click Save As... to save the file under a new name.

Click Print Prices & Portions for a report listing flow meter setup data.

Click Help if you have questions.

Click Read or Load the ECU to transfer data for all three setup tables (portion/price, PLU, flow meter) at the same time. Price format and volume units at the ECU and computer must match. You cannot perform other operations while the data is being transferred.

Print Setup Data

You can print a copy of portion size, price, PLU and flow meter data entered at the computer.

Available in Option Package(s): 744-Basic 744-CR AR FM ID DX

■ To print setup data:

1. Select **Setup** from the **All-Bottle Manager** menu bar.
2. Select **Prices/Portions/PLUs...** from the **Setup** menu.

The **Price/Portion/PLU Setup** screen is displayed with the **Prices & Portions** tab selected.

3. Perform the necessary steps to enter or edit the correct data in any of the three tabs (**Prices & Portions**, **PLUs**, **Flow Meters**). See *Define Portion Sizes and Prices*, *Define PLUs* and *Set Flow Meter Counts and Price per Unit* in this section.
4. To print price, portion and flow meter data: Click **Print Prices & Portions**.

To print PLU data: Click **Print PLUs**.

The Price and Portion Report or the PLU Report appears in a **Notepad** window. You can now treat the report as you would any other computer file (save, print, delete, etc.).

5. Select **File** from the menu bar.
6. To print the report: select **Print** from the **File** menu.
7. To save a new report: select **Save As...** from the **File** menu, enter the name of the file and click **OK**.
8. To exit the **Notepad** window and return to the **Price/Portion/PLU Setup** screen: select **Exit** from the **File** menu.

Notes

- The setup data printed from the **Notepad** window shows the current entries in the **Price/Portion/PLU Setup** screen. It does not reflect the current entries in the ECU unless you just performed a **Read ECU** or **Load ECU** and made no further changes to the **Setup** screen.
- The setup data reports are distinguished from other sales or ECU reports by the words "Current Settings" rather than "Station" at the top of the report.

The Notepad window

Select Save As... to save the report to a new file.

Select Print to send the report to a printer.

Select Exit to return to the Setup screen.

Untitled - Notepad

File Edit Search Help

New
Open...
Save
Save As...
Page Setup...
Print
Exit

Berg All-Bottle Price/Portion Report

ugs Date: 10-16-1996 Time: 09:42:50

	Small		Regular		Large		Special	
	Size	Price	Size	Price	Size	Price	Size	Price
Code 2	2.00	1.25	4.00	2.00	6.00	3.00	3.50	1.75
Code 3	2.00	1.50	4.00	2.25	6.00	3.25	3.50	2.00
Code 4	2.00	1.00	4.00	1.75	6.00	2.75	3.50	1.50
Code 5	2.00	1.25	4.00	2.25	6.00	3.00	3.50	1.75
Code 6	2.00	1.25	4.00	2.25	6.00	3.00	3.50	2.00
Code 7	2.00	1.25	4.00	2.25	6.00	3.00	3.50	2.00

Flow Meter #1 Price/oz Price Level A 0.30
Flow Meter #2 Price/oz Price Level A 0.25
Flow Meter #3 Price/oz Price Level A 1.00

Price Level B

	Small		Regular		Large		Special	
	Size	Price	Size	Price	Size	Price	Size	Price
Code 1	2.00	1.00	4.00	2.00	6.00	3.00	3.50	1.75
Code 2	2.00	1.25	4.00	2.25	6.00	3.25	3.50	2.00
Code 3	2.00	1.50	4.00	2.50	6.00	3.50	3.50	2.25
Code 4	2.00	1.00	4.00	2.00	6.00	3.00	3.50	1.75
Code 5	2.00	1.25	4.00	2.25	6.00	3.25	3.50	2.00
Code 6	2.00	1.25	4.00	2.25	6.00	3.25	3.50	2.00
Code 7	2.00	1.25	4.00	2.25	6.00	3.25	3.50	2.00

Flow Meter #1 Price/oz Price Level B 0.40
Flow Meter #2 Price/oz Price Level B 0.35
Flow Meter #3 Price/oz Price Level B 1.25

Key Assignment List

The key assignment list in the **All-Bottle Manager** software is identical to the one at the ECU. Space is provided to list up to fifteen servers giving them active status at the ECU with a proper access key.

Available in Option Package(s): 744-Basic 744-CR AR FM ID DX

■ **To access the key assignment list:**

1. Select **Setup** from the **All-Bottle Manager** menu bar.
2. Select **Server IDs...** from the **Setup** menu.

■ **To edit the key assignment list from the ECU:**

1. Click **Read ECU**.

■ **To open a previously saved file:**

1. Click **Open**.
2. Enter the name of the file you want to edit. Click **OK**.

■ **To enter or change server names:**

1. Select the correct row in the table.
2. Enter the server name.

■ **To save your entries to a file you've opened:**

1. Click **Save**.

■ **To save your entries in a new file:**

1. Click **Save As....**
2. Enter the name you want to give your file. Click **OK**.

■ **To download the key assignment list to the ECU:**

1. Click **Load ECU**.

■ **To print the key assignment list:**

1. Click **Report**.
2. View the Server ID report in a **Notepad** window.
3. Select **File** from the menu bar.
4. Select **Print** from the **File** menu.

The name in the list must exactly match the name assigned to the server key.

If you make a mistake, use the Delete key to erase any name currently highlighted.

Use the arrow keys, the Tab key, the Enter key or a mouse to move between rows.

Click Open to view a previously saved file.

Click Save to replace previous data in the file with the new data.

Click Save As... to save the file under a new name.

Click Report to print the list of servers

Click Read or Load the ECU to transfer data to or from the ECU. Be sure you've enabled the communication option at the ECU. You cannot perform other operations while the data is being transferred.

Click Close to return to the main menu.

Click Help if you have questions.

No.	Server Name
1	Alice
2	Mike
3	Ron
4	Julie
5	
6	
7	
8	
9	
10	
11	
12	
13	
14	
15	

Buttons: Open..., Read ECU, Close, Save, Load ECU, Help, Save As..., Report

Generate Reports

Any reports that can be generated from your **All-Bottle 744** or **1544** ECU can be generated with the **All-Bottle Manager** software. For detailed information on each report see the *Reports* section.

Available in Option Package(s): **744-Basic** **744-CR** **AR** **FM** **ID** **DX**

■ To generate reports:

1. Be sure you've enabled the communication option at the ECU.
2. Select **Reports...** from the **All-Bottle Manager** menu bar.
3. Highlight the report you want to run from the **Reports** list.
4. Click **OK**, or double-click the mouse on the desired report.
5. View the report in a **Notepad** window.

■ To print the report:

1. Select **File** from the menu bar.
2. Select **Print** from the **File** menu.

■ To save the report in a new file:

1. Select **File** from the menu bar.
2. Click **Save As...**
3. Enter the name you want to give your file.
4. Click **OK**.

Notes

- If you request a report that is not valid for your option package, the software displays an error message and you cannot access the report. Option packages **744-Basic** and **CR** cannot access any reports with the software.
- If you have option package **ID** or **DX** and you run a **Summary Z by Server** or **Summary X by Server** report, you will see a form listing the current active servers when you request the report. To run the report, double-click on the desired server or highlight the server's name and click **OK**.

All-Bottle Reports

Report:

- Summary Z
- Detailed Z
- Summary X
- Detailed X
- All Server Summary Z
- All Server Summary X
- Summary Z by Server
- Summary X by Server
- Last Z
- Hourly Sales
- Price Level Changes
- Configuration
- Prices & Portions
- PLUs

OK Close Help

You can only generate these reports if you have option package ID or DX.

You can only generate reports with this form if you have option package AR, FM, ID or DX.

Use the arrow keys, the Tab key or a mouse to highlight a report. Use the Enter key or double-click a mouse to run a highlighted report.

Click OK to generate the highlighted report. Click Close to return to the main menu. Click Help if you have questions.

Config - Notepad

File Edit Search Help

- New
- Open...
- Save
- Save As...
- Page Setup...
- Print
- Exit

Berg All-Bottle Configuration Report

Date: 04/23/96 Time: 09:05:47 PM

1.09

N

Change Manager Only Y

ur Y

Server Menu Active Y

Linefeeds to Printer Y

Enable OFF Signal Y

Restart Pour Delay (seconds) 2

Current Price Level Price Level B

Z Number 4

Price Format 999.99

Decimal Char. Period

Volume Units oz

Date Format MM/DD/YY

Time Format 12 hour

Baud Rate 19200

Parity No Parity

Word Length 8-bits

Stop Bits 1 Stop Bit

Servers

Alice	Z Number	3
Mike	Z Number	3
Ron	Z Number	3
Julie	Z Number	3

The Notepad window

Click Save As... to save the report to a new file.

Click Print to send the report to a printer.

Click Exit to return to the Reports screen.

Perform a Loopback Test

The **All-Bottle Manager** software provides diagnostic tests to verify communication between the ECU and your computer. The loopback test verifies you have a working, accessible COM port on your computer. You must have a loopback tester to connect to the port to perform this test.

Available in Option Package(s): 744-Basic 744-CR AR FM ID DX

■ To perform a loopback test:

1. Attach the loopback tester to the COM port you want to test. You can connect the tester at various points in the connection (before or after the converter or cable) to verify a good connection with the equipment.
2. Select **Diagnostics** from the **All-Bottle Manager** menu bar.
3. Select **Loopback Test...** from the **Diagnostics** menu.
4. Click **Run** to begin testing.
5. Click **Stop** to end the test.
6. Click **Close** to return to the main menu.

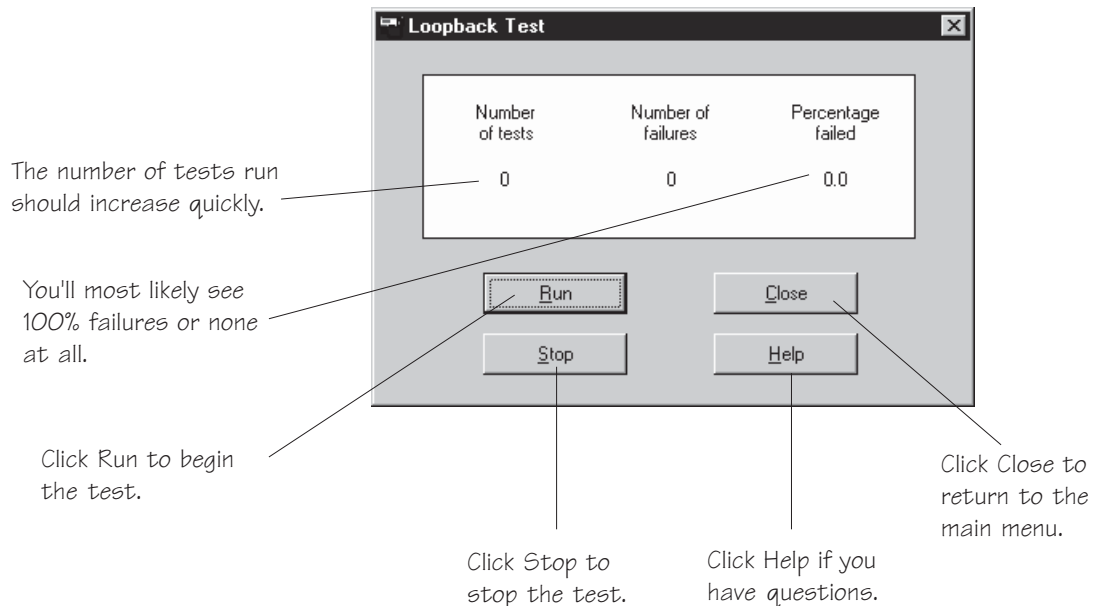

Perform a Communication Test

The communication test verifies the communication link between the ECU and your computer. It is very useful when you're troubleshooting a communication problem.

Available in Option Package(s): 744-Basic 744-CR AR FM ID DX

■ To perform a communication test:

1. Make sure the communication settings are correct at the ECU and the computer.
2. Make sure the communications option is enabled at the ECU.
3. Select **Diagnostics** from the **All-Bottle Manager** menu bar.
4. Select **Communication Test...** from the **Diagnostics** menu.
5. Click **Run** to begin testing.
6. Click **Stop** to end the test.
7. Click **Close** to return to the main menu.

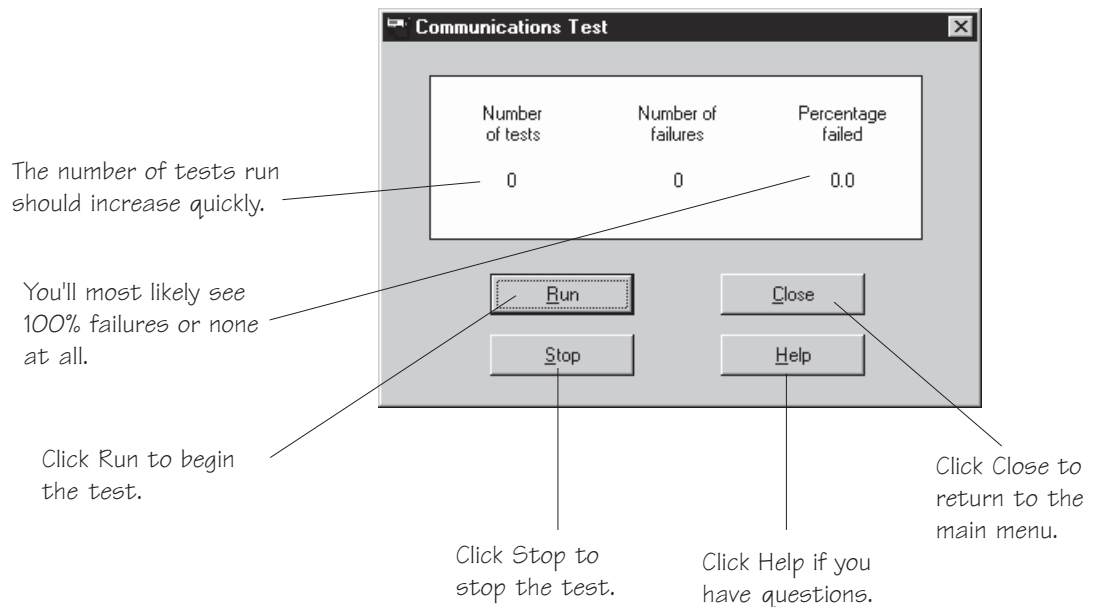

Check Option Package

If you are unsure which **All-Bottle 744** or **1544** option package is installed on your ECU, you can run this check with the **All-Bottle Manager** software to verify your package.

Available in Option Package(s): 744-Basic 744-CR AR FM ID DX

■ To check your option package:

1. Make sure the communication settings are correct at the ECU and the computer.
2. Make sure the communications option is enabled at the ECU.
3. Select **Diagnostics** from the **All-Bottle Manager** menu bar.
4. Select **Check Option Package** from the **Diagnostics** menu.



Click OK to return to the main menu.

Diagnostic Mode

Diagnostic mode is an option of the **All-Bottle Manager** software that provides detailed information whenever errors occur. Berg Company service technicians may ask you to enable it if they are diagnosing a problem. Otherwise, you should leave this option disabled. By default, it is always disabled at program startup.

Available in Option Package(s): 744-Basic 744-CR AR FM ID DX

■ To enable or disable diagnostic mode:

1. Select **Diagnostics** from the **All-Bottle Manager** menu bar.
2. Select **Diagnostic Mode** from the **Diagnostics** menu.
3. Click in the **Diagnostic Mode on** box.

An **x** in the box enables diagnostic mode.

4. Click **OK** to return to the main menu.

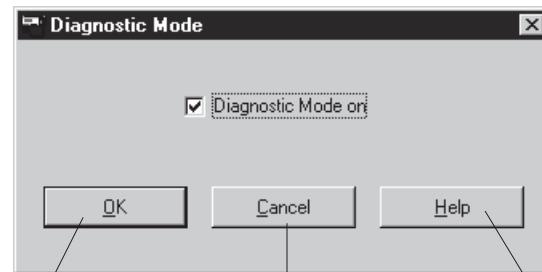

Click OK to save your choice and return to the main menu.

Click Cancel to return to the main menu without saving any changes.

Click Help if you have questions.

All-Bottle Manager Files

This is a list of some of the files used by the **All-Bottle Manager** Setup program. For information about deleting the **All-Bottle Manager** software from your system, see Windows 3.1 online help for uninstalling programs.

Available in Option Package(s): 744-Basic 744-CR AR FM ID DX

■ Files installed in the program directory:

These are the main program and help files.

ABMGR.EXE

BRGABC10.DLL

ABMGR.HLP

■ Files created by the software:

These files are not installed by the Setup program, but are created as needed by the **All-Bottle Manager** software and saved (by default) in the program directory, except for BERG.INI.

BERG.INI

This file is used to keep track of your session settings so you don't need to reset them every time you use the program. The settings saved are COM Port, Baud Rate, ECU Type, Price Format and Volume Units. This file is also used by other Berg software products that may be installed on your computer, and is stored in the WINDOWS directory.

*.PPN

Price/Portion/PLU file(s). See *Define Portion Sizes and Prices* in this section for more details about these files.

*.SRV

Server ID key assignment list file(s). See *Key Assignment List* in this section for more details about these files.

DEBUG.INF

Created or updated when running in Diagnostic Mode. This file contains detailed output which may help a Berg service representative diagnose a problem with the software. You can safely delete this file at any time.



SECTION

11

**All-Bottle 744/1544
Specifications**

All-Bottle 744/1544 Specifications

Basic System

Electronic Control Unit size :	3.75 in (95.3 mm) H 10.25 in (260.4 mm) W 5.25 in (133.4 mm) D
Dispenser type:	Patented bottle pourers and activator ring
Number of brands:	Unlimited
Number of price codes:	Seven for 744 , Fifteen for 1544
Portion size:	1/8 to 10 ounces (3.7 to 295.7 ml)
Number of portion sizes:	Four (presetable)/code/price level
Number of price levels:	Four – with unique portion per level
Calibration:	By portion
Display type:	LCD 2x20 (shows portions dispensed/code and price level)

Options

Interface capabilities:	Computer Minimum system requirements: 386 DX IBM compatible PC Windows 3.1 4 MB RAM VGA monitor 3 MB available hard drive space Electronic Cash Register (ECR) Printer output – Centronics or RS-485 ports
Advanced reporting:	Reports formatted for an 80-column printer
Server ID:	Access keys (Manager & up to 15 Server keys)
Remote Server Access Box:	Additional access for Server keys 2.5 in (64 mm) H 5.0 in (127 mm) W 4.5 in (115 mm) D
Flow meter input:	Monitor up to three Berg pulse-output flow meters 1 required per beer, wine, soda or juice line Uses 29/32 in (23 mm) nuts & tailpieces 1.2 in (30 mm) H 1.0 in (25 mm) W 2.4 in (61 mm) L

Technical

Electrical Requirements:	100-240 VAC, 50-60 Hz 0.7A, 5 VA Installation category II Pollution Degree 2 Mains supply voltage fluctuations shall not exceed 10 percent of the nominal supply voltage.
Protective Earthing Requirements:	The system must be connected to a properly grounded mains supply with an IEC approved three pronged power cord.
Environmental Conditions:	Maximum relative humidity 50-80 R.H. Operating temperature range 5°-40° C (41°-104° F). Maximum altitude 2,000 m (6,562 ft).
Fuses used in product:	Berg PN 8007422 For North American installations (1/4 x 1, CSA certified) Littlefuse 313000 Bussman MDL-3 For European installations (5 x 20 mm, designed to IEC 127) Littlefuse 2183.15 Bussman GDL-3.15A



SECTION **12** Troubleshooting

The 744 or 1544 ECU will not power up when plugged in

- Is the power supply plugged into the J4B (external solenoid) port instead of the J5A port on the back of the ECU?
- Is the power supply plugged securely into the J5A port?

The 744 or 1544 does not dispense All-Bottle portions at all

- Have all the portion sizes been set to 0? (This can happen with the Clear Prices option in the Manager Menu.)
- Has the Disable Unit option been set to Y?

Option package ID or DX does not dispense when a Server key is inserted

- Is there another valid Server key in the other key slot? If so, the display reads “Both Keys” and pouring is disabled. (The ECU doesn’t know to which key to assign the pour.)
- Does the name on the Server key exactly match a name in the Key Assignment list? The names are case sensitive.

The All-Bottle portions are inaccurate when you pour

- Are the correct portion sizes defined?
- Are the correct volume units defined?
- The All-Bottle calibration values may need to be adjusted.
- The coded pourers may need to be cleaned.

You can’t access the Dealer Menu at the ECU

- Are you using a valid Dealer key?

You can’t access the Manager Menu at the ECU

- Are you using a valid Dealer or Manager key?

The Manager Menu doesn’t work below the Communications option

- Comm Option Active is set to Y (used to communicate with a computer). Set to N to access the rest of the Manager Menu.

Printed reports are double-spaced where they should be single-spaced

- Reconfigure the printer to suppress linefeeds, or set Linefeeds to Printer (in the Manager Menu) to N.

You can't clear cumulative sales, even with the password

- Did you enter the password exactly as it is defined? The password is case sensitive.

You are using an A/B switchbox with multiple ECUs and an active ECU reports all zeros on a Z report

- Did you just run a Z report for one ECU and forget to change the switchbox to another ECU?

You can't access the Server Menu at the ECU

- Are you using a valid Dealer, Manager or Server key?
- Is the name on the key listed in the Key Assignment list? The names are case sensitive.
- Is the Server Menu Active option (in the Manager Menu) set to N? Set it to Y.
- Is the Communications option (in the Manager Menu) set to Y? Set it to N.

The flow meters are not generating any sales data at the ECU

- Check the wiring connection between each flow meter and the ECU.

The reported flow meter volumes are inaccurate

- The flow meter count values need to be adjusted.

The 744 or 1544 ECU will not communicate with the All-Bottle Manager software

- Is the ECU powered up?
- Are all cable connections between the ECU and computer secure?
- Do the serial port settings at the computer and the ECU match? They must show the same baud rates, word length, parity and number of stop bits.
- Has the Communication option (in the Manager Menu) been set to Y?
- Use a loopback tester to pinpoint the breakdown in communication.
- Perform a communication test with the software. You can make adjustments while the test is running to see what solves the problem.

You print Prices/Portions or PLUs from the Manager's Price/Portion/PLU Setup screen and the numbers don't accurately reflect what is in the ECU

- These two print options only print what is currently in the Setup screen's tables, not what is in the ECU. Select Read ECU before printing (or just run the Price/Portion report or the PLU report from the Reports...menu of the software).

You get a Version Verify dialog box when running the Manager software

- You'll see this when a file needed by the software has been deleted, moved or overwritten by an earlier version that may not work. Click on the filename(s) to see the version the software needs (Reference File) and the one it found on your system, if any (Actual File). Reinstalling the All-Bottle Manager software from the installation disk will usually fix this problem.

SECTION

13

Bar Management Tips

The suggestions in this section can help you manage your bar using the **All-Bottle 744** or **1544** system. They're proven tips to help you establish a uniform pricing structure that is consistent, manageable and easily trackable in the event of theft or breakage.

Coded Pourer Assignment	13-2
Portioning Guidelines	13-8
Pricing Guidelines	13-10

Coded Pourer Assignment

Categorizing your liquor helps you determine the number of coded pourers needed.

Available in Option Package(s): 744-Basic 744-CR AR FM ID DX

Coded Pourers The price codes on the All-Bottle coded pourers are determined by the placement of the metal coding bands on the pourers.

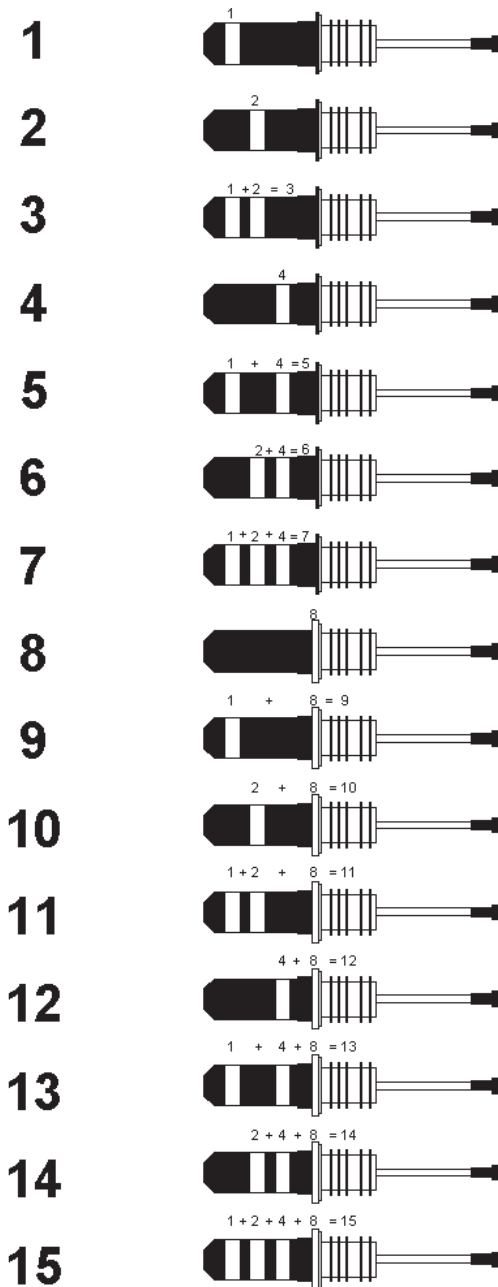

Categories of Liquor

One example of organizing your liquor by price codes is the following:

Code 1 Well Liquor

Code 2 Call Liquor

Code 3 Premium Liquor

Code 4 Domestic Cordials

Code 5 Premium Cordials

Code 6 Sherry

Code 7 Cognac

Use the **All-Bottle 744/1544 Pourer Worksheet** to categorize every type or brand of liquor used at the bar. Make additional copies of the list if necessary.

Free Poured Brands

Some brands will continue to be free-poured and should not be entered on the list. They include Bailey's Irish Cream (and substitutes), Triple Sec, Galliano, Sweet Vermouth, Dry Vermouth, Creme de Cassis and Creme de Noya.

These items, with the exception of Bailey's (which will not work well on the system), are used like orange juice in a Screwdriver. They are mixers and have no retail value. However, if your customers frequently order any of these brands on the rocks or up, you should plan to lock them up with the appropriate pourers and enter them on the list.

Number of Pourers Needed

When you've listed each brand, use the **All-Bottle 744/1544 Pourer Worksheet** to determine the quantity of each pourer needed. List the number of bottles of each brand used in the racks and reserve cabinets (par stock).

Include enough pourers to avoid having the bar restocked in mid-shift. Typically, you should have enough liquor locked up with coded pourers for twenty-four hours of operation.

For example, if there are three speed racks with one bottle of bar vodka in each plus eight bottles in the par stock for backup, the quantity of pourers needed for bar vodka would be eleven.

All-Bottle 744/1544 Pourer Worksheet

Brand	Rack Bottles	Reserve Bottles	
_____	<input type="checkbox"/>	<input type="checkbox"/>	
_____	<input type="checkbox"/>	<input type="checkbox"/>	
_____	<input type="checkbox"/>	<input type="checkbox"/>	
_____	<input type="checkbox"/>	<input type="checkbox"/>	
_____	<input type="checkbox"/>	<input type="checkbox"/>	
_____	<input type="checkbox"/>	<input type="checkbox"/>	
_____	<input type="checkbox"/>	<input type="checkbox"/>	
_____	<input type="checkbox"/>	<input type="checkbox"/>	
_____	<input type="checkbox"/>	<input type="checkbox"/>	
_____	<input type="checkbox"/>	<input type="checkbox"/>	
_____	<input type="checkbox"/>	<input type="checkbox"/>	
_____	<input type="checkbox"/>	<input type="checkbox"/>	
Total Pourers	<input type="checkbox"/>	+ <input type="checkbox"/>	= <input type="checkbox"/>

1

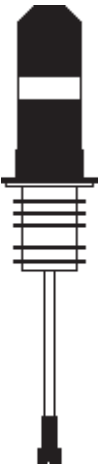
Brand	Rack Bottles	Reserve Bottles	
_____	<input type="checkbox"/>	<input type="checkbox"/>	
_____	<input type="checkbox"/>	<input type="checkbox"/>	
_____	<input type="checkbox"/>	<input type="checkbox"/>	
_____	<input type="checkbox"/>	<input type="checkbox"/>	
_____	<input type="checkbox"/>	<input type="checkbox"/>	
_____	<input type="checkbox"/>	<input type="checkbox"/>	
_____	<input type="checkbox"/>	<input type="checkbox"/>	
_____	<input type="checkbox"/>	<input type="checkbox"/>	
_____	<input type="checkbox"/>	<input type="checkbox"/>	
_____	<input type="checkbox"/>	<input type="checkbox"/>	
_____	<input type="checkbox"/>	<input type="checkbox"/>	
_____	<input type="checkbox"/>	<input type="checkbox"/>	
Total Pourers	<input type="checkbox"/>	+ <input type="checkbox"/>	= <input type="checkbox"/>

2

Brand	Rack Bottles	Reserve Bottles	
_____	<input type="checkbox"/>	<input type="checkbox"/>	
_____	<input type="checkbox"/>	<input type="checkbox"/>	
_____	<input type="checkbox"/>	<input type="checkbox"/>	
_____	<input type="checkbox"/>	<input type="checkbox"/>	
_____	<input type="checkbox"/>	<input type="checkbox"/>	
_____	<input type="checkbox"/>	<input type="checkbox"/>	
_____	<input type="checkbox"/>	<input type="checkbox"/>	
_____	<input type="checkbox"/>	<input type="checkbox"/>	
_____	<input type="checkbox"/>	<input type="checkbox"/>	
_____	<input type="checkbox"/>	<input type="checkbox"/>	
_____	<input type="checkbox"/>	<input type="checkbox"/>	
_____	<input type="checkbox"/>	<input type="checkbox"/>	
Total Pourers	<input type="checkbox"/>	+ <input type="checkbox"/>	= <input type="checkbox"/>

3

Brand	Rack Bottles	Reserve Bottles	
_____	<input type="checkbox"/>	<input type="checkbox"/>	
_____	<input type="checkbox"/>	<input type="checkbox"/>	
_____	<input type="checkbox"/>	<input type="checkbox"/>	
_____	<input type="checkbox"/>	<input type="checkbox"/>	
_____	<input type="checkbox"/>	<input type="checkbox"/>	
_____	<input type="checkbox"/>	<input type="checkbox"/>	
_____	<input type="checkbox"/>	<input type="checkbox"/>	
_____	<input type="checkbox"/>	<input type="checkbox"/>	
_____	<input type="checkbox"/>	<input type="checkbox"/>	
_____	<input type="checkbox"/>	<input type="checkbox"/>	
_____	<input type="checkbox"/>	<input type="checkbox"/>	
_____	<input type="checkbox"/>	<input type="checkbox"/>	
Total Pourers	<input type="checkbox"/>	+ <input type="checkbox"/>	= <input type="checkbox"/>

4

All-Bottle 744/1544 Pourer Worksheet

Brand	Rack Bottles	Reserve Bottles			
_____	<input type="checkbox"/>	<input type="checkbox"/>	 5		
_____	<input type="checkbox"/>	<input type="checkbox"/>			
_____	<input type="checkbox"/>	<input type="checkbox"/>			
_____	<input type="checkbox"/>	<input type="checkbox"/>			
_____	<input type="checkbox"/>	<input type="checkbox"/>			
_____	<input type="checkbox"/>	<input type="checkbox"/>			
_____	<input type="checkbox"/>	<input type="checkbox"/>			
_____	<input type="checkbox"/>	<input type="checkbox"/>			
_____	<input type="checkbox"/>	<input type="checkbox"/>			
_____	<input type="checkbox"/>	<input type="checkbox"/>			
_____	<input type="checkbox"/>	<input type="checkbox"/>			
_____	<input type="checkbox"/>	<input type="checkbox"/>			
Total Pourers	<input type="checkbox"/>	+	<input type="checkbox"/>	=	<input type="checkbox"/>

Brand	Rack Bottles	Reserve Bottles			
_____	<input type="checkbox"/>	<input type="checkbox"/>	 6		
_____	<input type="checkbox"/>	<input type="checkbox"/>			
_____	<input type="checkbox"/>	<input type="checkbox"/>			
_____	<input type="checkbox"/>	<input type="checkbox"/>			
_____	<input type="checkbox"/>	<input type="checkbox"/>			
_____	<input type="checkbox"/>	<input type="checkbox"/>			
_____	<input type="checkbox"/>	<input type="checkbox"/>			
_____	<input type="checkbox"/>	<input type="checkbox"/>			
_____	<input type="checkbox"/>	<input type="checkbox"/>			
_____	<input type="checkbox"/>	<input type="checkbox"/>			
_____	<input type="checkbox"/>	<input type="checkbox"/>			
_____	<input type="checkbox"/>	<input type="checkbox"/>			
Total Pourers	<input type="checkbox"/>	+	<input type="checkbox"/>	=	<input type="checkbox"/>

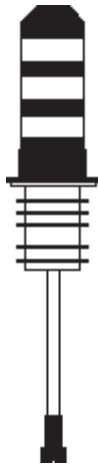
Brand	Rack Bottles	Reserve Bottles			
_____	<input type="checkbox"/>	<input type="checkbox"/>	 7		
_____	<input type="checkbox"/>	<input type="checkbox"/>			
_____	<input type="checkbox"/>	<input type="checkbox"/>			
_____	<input type="checkbox"/>	<input type="checkbox"/>			
_____	<input type="checkbox"/>	<input type="checkbox"/>			
_____	<input type="checkbox"/>	<input type="checkbox"/>			
_____	<input type="checkbox"/>	<input type="checkbox"/>			
_____	<input type="checkbox"/>	<input type="checkbox"/>			
_____	<input type="checkbox"/>	<input type="checkbox"/>			
_____	<input type="checkbox"/>	<input type="checkbox"/>			
_____	<input type="checkbox"/>	<input type="checkbox"/>			
_____	<input type="checkbox"/>	<input type="checkbox"/>			
Total Pourers	<input type="checkbox"/>	+	<input type="checkbox"/>	=	<input type="checkbox"/>

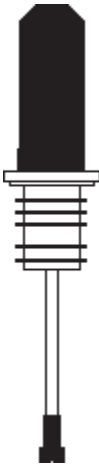
Brand	Rack Bottles	Reserve Bottles			
_____	<input type="checkbox"/>	<input type="checkbox"/>	 8		
_____	<input type="checkbox"/>	<input type="checkbox"/>			
_____	<input type="checkbox"/>	<input type="checkbox"/>			
_____	<input type="checkbox"/>	<input type="checkbox"/>			
_____	<input type="checkbox"/>	<input type="checkbox"/>			
_____	<input type="checkbox"/>	<input type="checkbox"/>			
_____	<input type="checkbox"/>	<input type="checkbox"/>			
_____	<input type="checkbox"/>	<input type="checkbox"/>			
_____	<input type="checkbox"/>	<input type="checkbox"/>			
_____	<input type="checkbox"/>	<input type="checkbox"/>			
_____	<input type="checkbox"/>	<input type="checkbox"/>			
_____	<input type="checkbox"/>	<input type="checkbox"/>			
Total Pourers	<input type="checkbox"/>	+	<input type="checkbox"/>	=	<input type="checkbox"/>

All-Bottle 744/1544 Pourer Worksheet

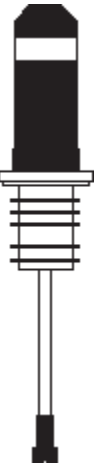
Brand	Rack Bottles	Reserve Bottles			
_____	<input type="checkbox"/>	<input type="checkbox"/>	 9		
_____	<input type="checkbox"/>	<input type="checkbox"/>			
_____	<input type="checkbox"/>	<input type="checkbox"/>			
_____	<input type="checkbox"/>	<input type="checkbox"/>			
_____	<input type="checkbox"/>	<input type="checkbox"/>			
_____	<input type="checkbox"/>	<input type="checkbox"/>			
_____	<input type="checkbox"/>	<input type="checkbox"/>			
_____	<input type="checkbox"/>	<input type="checkbox"/>			
_____	<input type="checkbox"/>	<input type="checkbox"/>			
_____	<input type="checkbox"/>	<input type="checkbox"/>			
_____	<input type="checkbox"/>	<input type="checkbox"/>			
_____	<input type="checkbox"/>	<input type="checkbox"/>			
Total Pourers	<input type="checkbox"/>	+	<input type="checkbox"/>	=	<input type="checkbox"/>

Brand	Rack Bottles	Reserve Bottles			
_____	<input type="checkbox"/>	<input type="checkbox"/>	 10		
_____	<input type="checkbox"/>	<input type="checkbox"/>			
_____	<input type="checkbox"/>	<input type="checkbox"/>			
_____	<input type="checkbox"/>	<input type="checkbox"/>			
_____	<input type="checkbox"/>	<input type="checkbox"/>			
_____	<input type="checkbox"/>	<input type="checkbox"/>			
_____	<input type="checkbox"/>	<input type="checkbox"/>			
_____	<input type="checkbox"/>	<input type="checkbox"/>			
_____	<input type="checkbox"/>	<input type="checkbox"/>			
_____	<input type="checkbox"/>	<input type="checkbox"/>			
_____	<input type="checkbox"/>	<input type="checkbox"/>			
_____	<input type="checkbox"/>	<input type="checkbox"/>			
Total Pourers	<input type="checkbox"/>	+	<input type="checkbox"/>	=	<input type="checkbox"/>

Brand	Rack Bottles	Reserve Bottles			
_____	<input type="checkbox"/>	<input type="checkbox"/>	 11		
_____	<input type="checkbox"/>	<input type="checkbox"/>			
_____	<input type="checkbox"/>	<input type="checkbox"/>			
_____	<input type="checkbox"/>	<input type="checkbox"/>			
_____	<input type="checkbox"/>	<input type="checkbox"/>			
_____	<input type="checkbox"/>	<input type="checkbox"/>			
_____	<input type="checkbox"/>	<input type="checkbox"/>			
_____	<input type="checkbox"/>	<input type="checkbox"/>			
_____	<input type="checkbox"/>	<input type="checkbox"/>			
_____	<input type="checkbox"/>	<input type="checkbox"/>			
_____	<input type="checkbox"/>	<input type="checkbox"/>			
_____	<input type="checkbox"/>	<input type="checkbox"/>			
Total Pourers	<input type="checkbox"/>	+	<input type="checkbox"/>	=	<input type="checkbox"/>

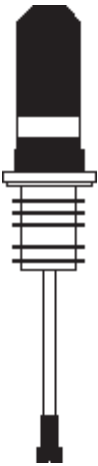
Brand	Rack Bottles	Reserve Bottles			
_____	<input type="checkbox"/>	<input type="checkbox"/>	 12		
_____	<input type="checkbox"/>	<input type="checkbox"/>			
_____	<input type="checkbox"/>	<input type="checkbox"/>			
_____	<input type="checkbox"/>	<input type="checkbox"/>			
_____	<input type="checkbox"/>	<input type="checkbox"/>			
_____	<input type="checkbox"/>	<input type="checkbox"/>			
_____	<input type="checkbox"/>	<input type="checkbox"/>			
_____	<input type="checkbox"/>	<input type="checkbox"/>			
_____	<input type="checkbox"/>	<input type="checkbox"/>			
_____	<input type="checkbox"/>	<input type="checkbox"/>			
_____	<input type="checkbox"/>	<input type="checkbox"/>			
_____	<input type="checkbox"/>	<input type="checkbox"/>			
Total Pourers	<input type="checkbox"/>	+	<input type="checkbox"/>	=	<input type="checkbox"/>

All-Bottle 744/1544 Pourer Worksheet

Brand	Rack Bottles	Reserve Bottles	
_____	<input type="checkbox"/>	<input type="checkbox"/>	
_____	<input type="checkbox"/>	<input type="checkbox"/>	
_____	<input type="checkbox"/>	<input type="checkbox"/>	
_____	<input type="checkbox"/>	<input type="checkbox"/>	
_____	<input type="checkbox"/>	<input type="checkbox"/>	
_____	<input type="checkbox"/>	<input type="checkbox"/>	
_____	<input type="checkbox"/>	<input type="checkbox"/>	
_____	<input type="checkbox"/>	<input type="checkbox"/>	
_____	<input type="checkbox"/>	<input type="checkbox"/>	
_____	<input type="checkbox"/>	<input type="checkbox"/>	
_____	<input type="checkbox"/>	<input type="checkbox"/>	
_____	<input type="checkbox"/>	<input type="checkbox"/>	
Total Pourers	<input type="checkbox"/>	+	<input type="checkbox"/>

13

Brand	Rack Bottles	Reserve Bottles	
_____	<input type="checkbox"/>	<input type="checkbox"/>	
_____	<input type="checkbox"/>	<input type="checkbox"/>	
_____	<input type="checkbox"/>	<input type="checkbox"/>	
_____	<input type="checkbox"/>	<input type="checkbox"/>	
_____	<input type="checkbox"/>	<input type="checkbox"/>	
_____	<input type="checkbox"/>	<input type="checkbox"/>	
_____	<input type="checkbox"/>	<input type="checkbox"/>	
_____	<input type="checkbox"/>	<input type="checkbox"/>	
_____	<input type="checkbox"/>	<input type="checkbox"/>	
_____	<input type="checkbox"/>	<input type="checkbox"/>	
_____	<input type="checkbox"/>	<input type="checkbox"/>	
_____	<input type="checkbox"/>	<input type="checkbox"/>	
Total Pourers	<input type="checkbox"/>	+	<input type="checkbox"/>

14

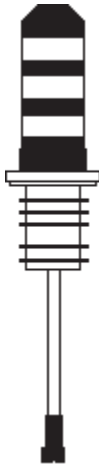
Brand	Rack Bottles	Reserve Bottles	
_____	<input type="checkbox"/>	<input type="checkbox"/>	
_____	<input type="checkbox"/>	<input type="checkbox"/>	
_____	<input type="checkbox"/>	<input type="checkbox"/>	
_____	<input type="checkbox"/>	<input type="checkbox"/>	
_____	<input type="checkbox"/>	<input type="checkbox"/>	
_____	<input type="checkbox"/>	<input type="checkbox"/>	
_____	<input type="checkbox"/>	<input type="checkbox"/>	
_____	<input type="checkbox"/>	<input type="checkbox"/>	
_____	<input type="checkbox"/>	<input type="checkbox"/>	
_____	<input type="checkbox"/>	<input type="checkbox"/>	
_____	<input type="checkbox"/>	<input type="checkbox"/>	
_____	<input type="checkbox"/>	<input type="checkbox"/>	
Total Pourers	<input type="checkbox"/>	+	<input type="checkbox"/>

15

Portioning Guidelines

Once you've categorized your liquor, you can determine which portion sizes are most appropriate for each category.

Available in Option Package(s): 744-Basic 744-CR AR FM ID DX

Small Portions of Liquor

Program the small portion sizes with the amount you'll use in mixed drinks.

For instance, if you sell an Ice Tea for \$3.00, you're charging 1.00 each for a small portion (1/2 shot) of Gin, Vodka and Rum.

A four liquor drink (Long Island Ice Tea) would therefore be priced at \$4.00 (1.00 x 4).

If a customer ordered a "call" Long Island Ice Tea using Beefeater, Smirnoff, Cuervo and Bacardi (call brands), the price would be \$5.00 (1.25 for a small portion of a call brand x 4). The Triple Sec is normally free poured (like Vermouth) as it has no retail value.

Regular and Large Portions of Liquor

Your glassware plays an important role in defining regular or large portion sizes. This is particularly true with rock drinks. The overriding factor in choosing between a regular or large portion size is how each portion looks in the glass.

For example, a 4 ounce Martini glass is typically served with 1 3/4 to 2 ounces of gin. An 8 ounce glass would need approximately 4 ounces of gin. Vermouth is free poured, so the difference between a regular Martini and an extra, extra, extra dry Martini is the amount of Vermouth poured, not more gin. The price of all well brand Martinis, whether they are regular, dry, up or on the rocks is the same. If your glassware necessitates your not pouring rock drinks with the regular portion, pour the large portion and charge the same price. Alternately, change your glassware so the regular size shot looks good.

Small Portions of Cordial

Program this portion size with the amount used for two liquor drinks.

For example, the recipe for a Black Russian calls for a small portion of Kahlua and a regular portion of vodka. If your Black Russian selling price is \$3.25 and you charge \$2.00 for the vodka, you are then charging \$1.25 for a small portion of Kahlua.

Using these prices, all two liquor drinks using well liquor and premium cordials are \$3.25. If a Smirnoff Black Russian is ordered, the price is \$3.50 (\$2.25 for a regular call vodka + 1.25 for a small premium cordial). A Black Russian made with Absolut is \$3.75 (\$2.50 for a regular premium vodka and 1.25 for a small premium cordial).

Regular Portions of Cordial

Use this portion size for up cordials as well as on the rocks drinks if your rock glass accommodates the amount. We strongly recommend a brandy snifter for up cordials. The presentation is elegant and you don't have to purchase as many types of glassware.

Large Portions of Cordial

Use this portion size for rock or cream drinks if your glassware makes it necessary. Of course, you should charge a higher price for the large portion. Typically, if you need to define a large portion for liquor on the rocks, you also need to define a large portion for a cordial on the rocks.

Pricing Guidelines

With your liquor categorized and portion sizes defined, it's easier to see your overall price structure and define the appropriate price for each portion.

Available in Option Package(s): 744-Basic 744-CR AR FM ID DX

Defining Prices

The **All-Bottle 744** or **1544** uses the concept of building your drink prices based on the ingredients used. The more expensive the liquor, the higher the price that is charged. This practice is usually standard with highballs, but it will now hold true on all multi-liquor drinks as well.

Example: The following prices are programmed into the ECU:

Bar Vodka	Regular portion	\$2.00
Call Vodka (Smirnoff)	Regular portion	2.25
Premium Vodka (Absolut)	Regular portion	2.50
Kahlua (premium cordial)	Small portion	1.25

If a customer orders a Black Russian, the price would be built as follows:

Bar Vodka Black Russian	2.00 + 1.25 =	3.25
Call Vodka Black Russian	2.25 + 1.25 =	3.50
Premium Vodka Black Russian	2.50 + 1.25 =	3.75

Using Price Levels

One example of four price levels used with the **All-Bottle 744** or **1544** is the following :

Happy Hour	price level A
Regular	price level B
Entertainment	price level C
Special and/or Promotion	price level D

In addition to changing the price of a drink for each price level, you can also change the portion size. For instance, you can reduce the size of a regular portion of well liquor from 1 1/8 ounce to 1 ounce during Happy Hour.

Some owners of the **All-Bottle 744** or **1544** that do not use price levels use this feature for shift pricing—morning shift (price level A), afternoon shift (price level B) and so on.



Index

A

Access key

- how to make a manager 4-4
- how to make a server 4-5
- how to pour with server 7-4, 7-6
- how to read 4-2
- how to read a remote server 4-3
- key assignment list 4-6
- key assignment list at the computer 10-18

Activator ring

- description of 1-4
- how to use 7-2, 7-3, 7-4

Activator ring holder 2-2

Advanced Reporting option package

- description of 1-2
- how to install a parallel printer interface 2-8
- how to install a serial printer or PC interface 2-10
- site assessment for 1-7

All Server Summary Reports 8-18

All-Bottle 744/1544Pourer Worksheet 13-4

AR. *See* Advanced Reporting option package

Arrow keys 1-11

B

Basic option package

- description of 1-2
- site assessment for 1-7

Battery based power supply 2-2

Baud rate

- how to set at the computer 10-4
- how to set at the ECU 3-14

C

Calibrate coded pourers 6-2

Change price levels 7-2

Change the EPROM 9-6

Check option package 10-24

Clean the coded pourers 9-3

Clean the ECU 9-2

Clear all prices, portions and PLUs 6-12

Clear All-Bottle prices, portions and PLUs 6-10

Clear cumulative sales 8-24

Clear flow meter prices 6-11

Coded Pourer Worksheet 13-4

Coded pourers

- description of 1-4
- how to assign to liquor 13-2
- how to calibrate 6-2
- how to clean 9-3
- how to install 2-4

Communication settings at the computer 10-4

Communication test 10-23

Computer communication

- how to change settings at the computer 10-4
- how to enable at the ECU 5-3

Computer interface 2-10

Configuration report 8-12

Country setup 3-2

CR. *See* Electronic Cash Register option package

Cumulative sales

- how to clear 8-24
- how to define a password for 3-10

D

Date format 3-7

Dealer Menu

- how to navigate 1-11
- list of options 1-12

Decimal character 3-5

Default messages option 3-12

Define flow meter price per unit 6-7

Define PLUs

- at the computer 10-12
- at the ECU 6-6

Define portion sizes

- at the computer 10-10
- at the ECU 6-4
- tips on 13-8

Define prices

- at the computer 10-10
- at the ECU 6-5
- tips on 13-10

Deluxe option package

- description of 1-2
- how to install a remote server access box 2-14
- how to install flow meters 2-12
- how to interface to a parallel printer 2-8
- how to interface to a serial printer or computer 2-10
- how to interface to an ECR 2-6
- site assessment for 1-7

Detailed reports 8-4

Diagnostic messages option 3-11

Diagnostic mode 10-25

Disable unit 5-2

DX. *See* Deluxe option package

E

ECR (Electronic Cash Register) interface 2-6

ECU (Electronic Control Unit)

- description of 1-4

- how to clean 9-2
- how to install 2-2
- specifications 11-2
- ECU battery 9-4
- ECU display window 1-11
- ECU menus
 - how to access 1-8
 - how to navigate 1-11
- Electronic Cash Register option package
 - description of 1-2
 - how to install an ECR interface 2-6
 - site assessment for 1-7
- Enable computer communication 5-3
- Enable OFF signal 3-17
- Enable price level change 5-4
- EPROM, how to change 9-6
- External solenoid output 2-16

F

- Flow meter
 - how to clear prices 6-11
 - how to control with server ID 2-16
 - how to define price per unit at the ECU 6-7
 - how to install 2-12
 - how to set counts and prices at the computer 10-14
 - how to set counts at the ECU 6-8
 - how to use with server ID 7-6
 - specifications 11-2
- Flow Meter option package
 - description of 1-2
 - how to install flow meters 2-12
 - site assessment for 1-7
- FM. *See* Flow Meter option package

G

- Gather customer setup information 1-7

H

- Hourly sales report 8-8

I

- ID. *See* Server ID option package
- Individual server summary reports
 - how to generate with the Manager Menu 8-20
 - how to generate with the Server Menu 8-22
- Install a parallel printer interface 2-8
- Install a remote server access box 2-14

- Install a serial printer or computer interface 2-10
- Install an ECR interface 2-6
- Install an external solenoid output 2-16
- Install an option board 9-8
- Install flow meters 2-12
- Install the coded pourers 2-4
- Install the ECU 2-2
- Install the software 10-2
- Installation game plan 1-6

K

- Key assignment list
 - how to define at the computer 10-18
 - how to define at the ECU 4-6

L

- Last Z report 8-6
- Linefeeds to printer option 3-16
- Loopback test 10-22

M

- Make a manager key 4-4
- Make a server key 4-5
- Manager Menu
 - how to access 1-9
 - how to navigate 1-11
 - list of options 1-13
- Manager software, how to install 10-2
- Managing liquor inventory 13-2

N

- Numbered seals. *See* Security seals

O

- Option board, how to install 9-8
- Option packages
 - AR. *See* Advanced Reporting option package
 - Basic. *See* Basic option package
 - CR. *See* Electronic Cash Register option package
 - description of 1-2
 - DX. *See* Deluxe option package
 - FM. *See* Flow Meter option package
 - how to check at the computer 10-24
 - ID. *See* Server ID option package
 - site assessment for 1-7

P

- Plastic insert
 - how to change 2-4
 - how to clean 9-3
- PLU report 8-16, 10-16
- PLUs
 - how to clear 6-10
 - how to define at the computer 10-12
 - how to define at the ECU 6-6
 - how to generate report 8-16
- Portion change lockout 6-13
- Portion sizes
 - how to clear 6-10
 - how to define at the computer 10-10
 - how to define at the ECU 6-4
 - how to generate a report 8-14
 - how to lockout changes 6-13
 - how to reset to regular after pour 5-5
 - tips on how to assign 13-8
- Pour a drink 7-2
- Pour with flow meters and server ID 7-6
- Pour with server ID 7-4
- Pourer inserts. *See* Plastic insert
- Pourer Worksheet 13-4
- Price format
 - how to define at the computer 10-5
 - how to define at the ECU 3-4
- Price level change
 - how to enable 5-4
- Price level change report 8-10
- Price levels
 - how to select when pouring 7-2
- Price/Portion report 8-14, 10-16
- Prices
 - how to clear 6-10
 - how to define at the computer 10-10
 - how to define at the ECU 6-5
 - how to generate a report 8-14
 - tips on how to assign 13-10
- Printer
 - interface to a parallel 2-8
 - interface to a serial 2-10

R

- Replace the ECU battery 9-4
 - Reports
 - all server summary 8-18
 - configuration 8-12
 - detailed 8-4
 - hourly sales 8-8
 - how to generate at the computer 10-20
 - individual server summary 8-20, 8-22
 - last Z 8-6
 - PLU 8-16, 10-16
 - price level change 8-10
 - price/portion 8-14, 10-16
 - summary 8-2
 - Reset after pour 5-5
 - Restart pour delay 5-7
 - Return to factory setup option 3-8
 - RS-232 to RS 485 converter 2-10, 2-18
- ## S
- Safety
 - precautions vi
 - terms and symbols vii
 - Security
 - disable unit 5-2
 - pour with server ID 7-4
 - security seals 2-4
 - Security seals 2-4
 - Select an ECU type 10-6
 - Serial port setup 3-14
 - Serial printer 2-18
 - Server ID
 - how to define list at the computer 10-18
 - how to define list at the ECU 4-6
 - how to generate report at the computer 10-18
 - how to pour with 7-4, 7-6
 - Server ID option package
 - description of 1-2
 - how to install a remote server access box 2-14
 - site assessment for 1-7
 - Server Menu
 - how to access 1-10
 - how to enable or disable 5-6
 - how to navigate 1-11
 - list of options 1-12
 - Set flow meter counts
 - at the computer 10-14
 - at the ECU 6-8
 - Set flow meter price per unit
 - at the computer 10-14
 - at the ECU 6-7
 - Solenoid. *See* External solenoid output

Specifications 1-5, 11-2
Station number 3-15
Summary reports 8-2
System components 1-4

T

Technical specifications 11-3
Test the system 2-20
Time and date
 how to set 3-13
 how to set date format 3-7
 how to set time format 3-6
Time format 3-6
Tools and materials required 1-14
Troubleshooting 12-2

V

Volume units
 how to define at the computer 10-5
 how to define at the ECU 3-3

X

X reports
 all server summary 8-18
 detailed 8-4
 individual server summary 8-20
 summary 8-2

Z

Z reports
 all server summary 8-18
 detailed 8-4
 individual server summary 8-20
 summary 8-2

